

FLEXWAVE

WP series

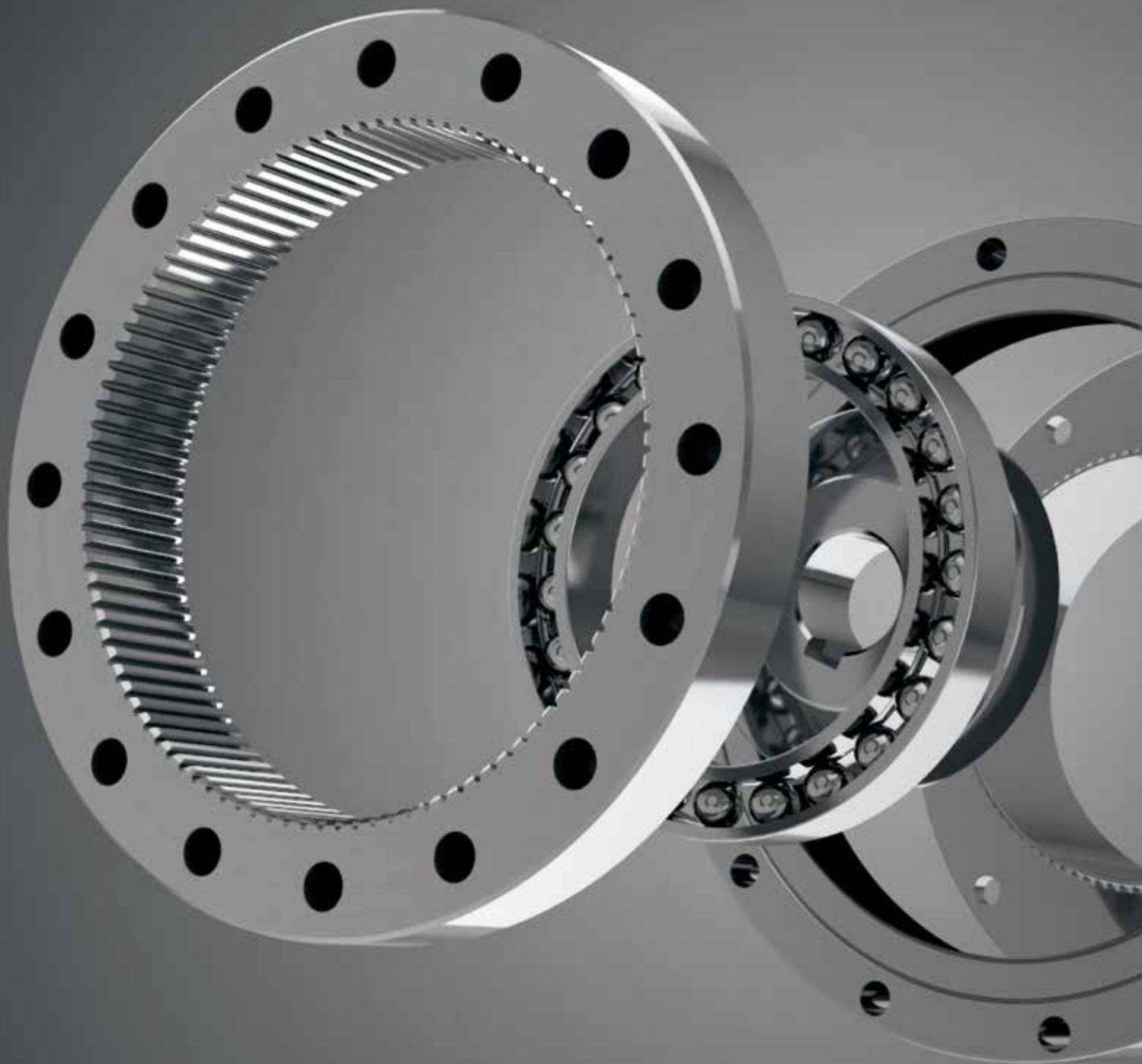

精密控制用减速机
A High precision reducer



“技术磨练”正是我们坚持的信念。
"Relentless Refinement of Technology",

FLEXWAVE

FLEX WAVE

日本电产新宝引以为傲的减速机技术。
通过不断完善技术，诞生了新型减速机。

机器人需求增加，针对精密控制用减速机的期待不断提高。

我们汇集迄今培养的技术力量，

完成了可以满足顾客要求的轻量紧凑、大速比、低背隙的减速机。

“FLEXWAVE”。抓住机遇，融入梦想。

活跃在机器人及机床等各种领域。

Nidec-Shimpo Corporation is a global leader in various high precision gear technologies. Based on increased demand for higher accuracy from machine tool and robot manufacturers, we've utilized our expertise to develop a new gear reduction mechanism.

This mechanism, called Flexwave, addresses the need for high torque density in a lightweight, compact package, combined with zero backlash and high reduction ratios. As a result, manufacturers of high performance robots, machine tools and other automation equipment will see increased performance and competitiveness in their respective markets.

进步成就世界。

Tractioning Your Future

INDEX

LineUp/零部件构成 LineUP / Parts Configuration	3
减速机机构 Reduction Mechanism	4
零部件名称/减速比 Parts Name / Reduction Ratio	4
型号选定 Model selection	5

标准型A

Standard type A

减速机型号 / 规格 Reducer Model / Specifications	6
尺寸表 Dimensions Table	7
寿命计算 (薄壁轴承) Life estimation (Elastic bearing)	12
寿命计算 (主轴承) Life estimation (Main bearing)	13
输入轴容许负荷 Maximum load at input shaft	15
润滑剂 Lubricant information	16
安装精度 Attachment fixture requirement	17
传导力矩 Transmitting Torque	18
输入部位构造 Input section structure	21
注意事项 Installation and assembly instructions	22
电机安装方法 Motor installation procedure	23
特性数据 Characteristics Data	24

高力矩型B2

High torque type B2

减速机型号 / 规格 Reducer Model / Specifications	33
尺寸表 Dimensions Table	34
寿命计算 (薄壁轴承) Life estimation (Elastic bearing)	39
寿命计算 (主轴承) Life estimation (Main bearing)	40
输入轴容许负荷 Maximum load at input shaft	42
润滑剂 Lubricant information	43
安装精度 Attachment fixture requirement	44
传导力矩 Transmitting Torque	45
输入部位构造 Input section structure	48
注意事项 Installation and assembly instructions	49
电机安装方法 Motor installation procedure	50
特性数据 Characteristics Data	51

偏平型D

Flat type D

减速机型号 / 规格 Reducer Model / Specifications	61
尺寸表 Dimensions Table	62
寿命计算 (薄壁轴承) Life estimation (Elastic bearing)	67
寿命计算 (主轴承) Life estimation (Main bearing)	68
输入轴容许负荷 Maximum load at input shaft	69
润滑剂 Lubricant information	70
安装精度 Attachment fixture requirement	71
传导力矩 Transmitting Torque	72
注意事项 Installation and assembly instructions	74
特性数据 Characteristics Data	75

FLEXWAVE Line up

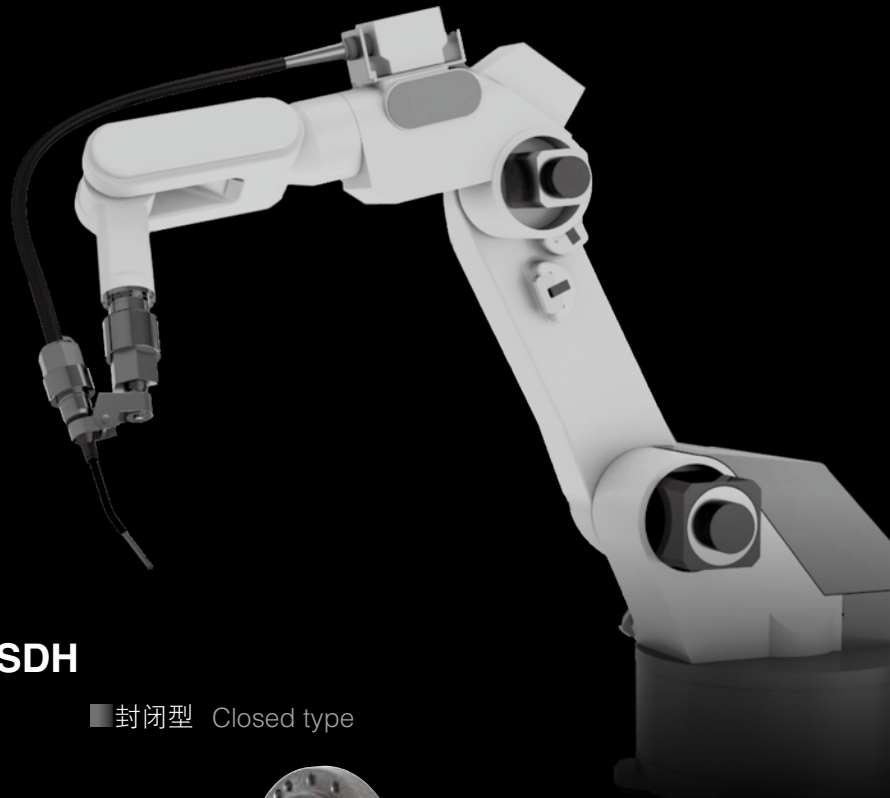

■ 开放型 Open type



WPU-□-□-SNH **WPU-□-□-SDH**
WPU-□-□-SRH

组合型 (中空轴) Hollow unit

■ 封闭型 Closed type



WPU-□-□-SNJ
WPU-□-□-SRJ

组合型 (输入轴) Input shaft unit



WPC-□-□-CF **WPC-□-□-CR**
WPC-□-□-CN **WPC-□-□-CD**

部件型 Component



WPS-□-□-SN **WPS-□-□-SD**
WPS-□-□-SR

简易组合型 Simple unit



WPU-□-□-CF **WPU-□-□-CD**
WPU-□-□-CN **WPU-□-□-CDH**
WPU-□-□-CR

组合型 Unit

零部件构成

Parts Configuration

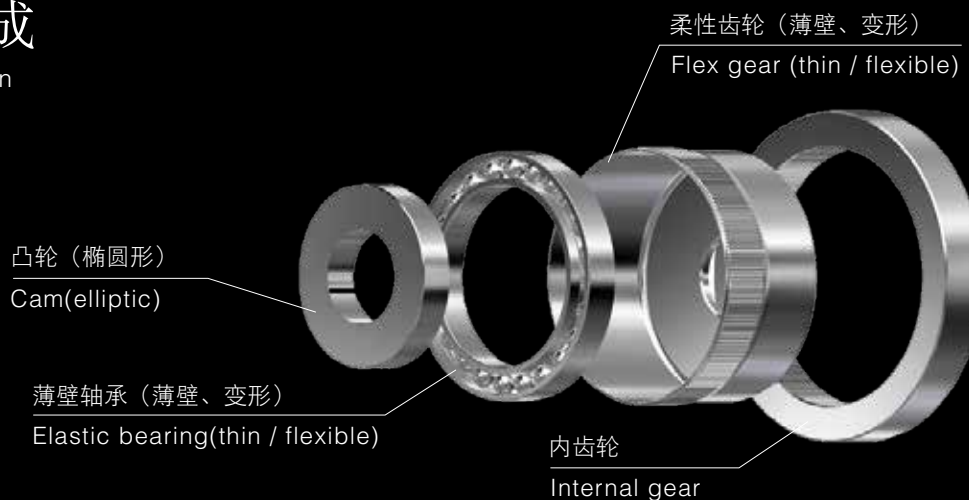

减速机构

Reduction Mechanism

- 通过凸轮使薄壁轴承、柔性齿轮呈椭圆形状变。
- 柔性齿轮与内齿轮在椭圆形长轴部分发生啮合。
- 固定内齿轮，使凸轮沿顺时针方向旋转360°时，柔性齿轮会沿逆时针方向移动内齿轮与柔性齿轮的齿数差部分。
- Flex gear and elastic bearing take elliptical shape with the cam inserted.
- Flex gear and internal gear are engaged at both ends of the long axis of the ellipse in a stable manner.
- With the internal gear fixed, when the cam (input) is rotated clockwise, the flex gear (output) rotates counterclockwise. And its rotational speed is determined by the tooth count differential between two gears.

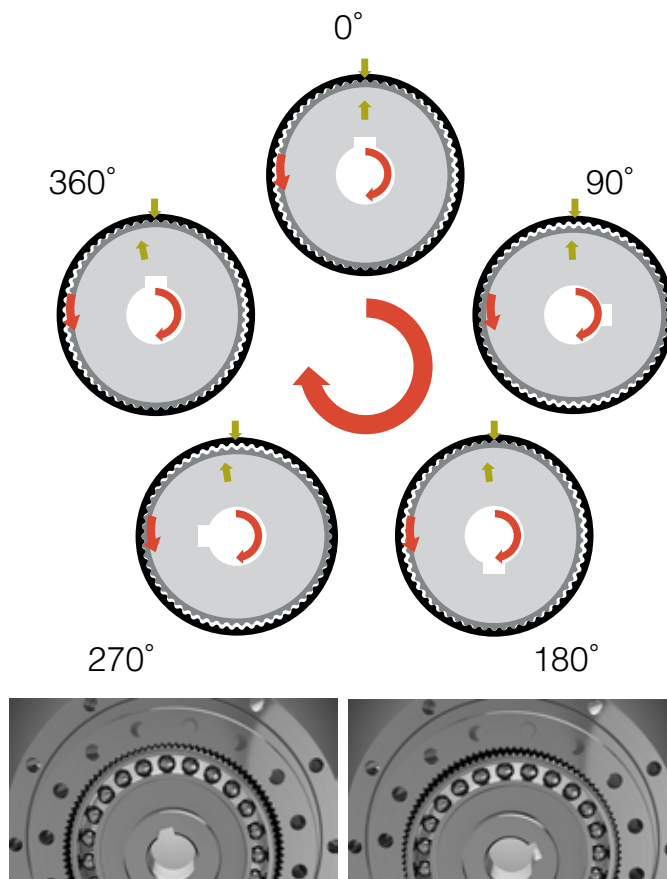

零部件名称

Parts Name

封闭型

Closed type

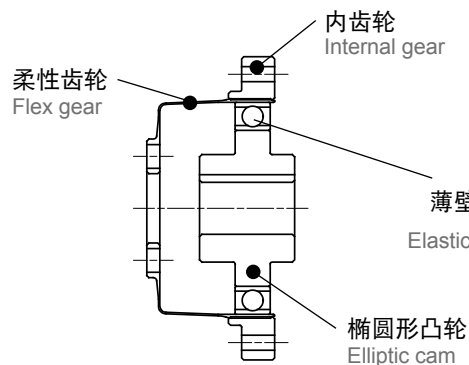

开放型

Open type

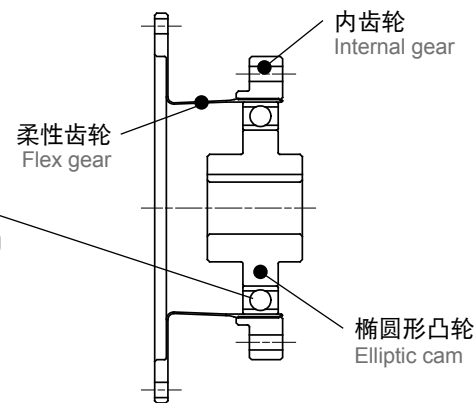

减速比

Reduction Ratio

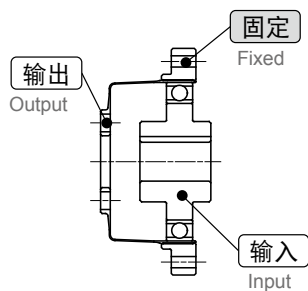

$$\text{减速比} = \frac{-1}{R}$$

※ 输入旋转方向与输出旋转方向相反

*The input and output rotation directions are opposite.

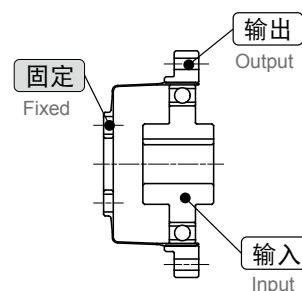

$$\text{减速比} = \frac{1}{R+1}$$

※ 输入旋转方向与输出旋转方向相同

*The input and output rotation directions are same.

● **R** 为减速机规格表中的减速比

R represents the 'Ratio' figure in the specifications table on the next page.

型号选定 *Model selection*

型号选定流程

Model selection flow

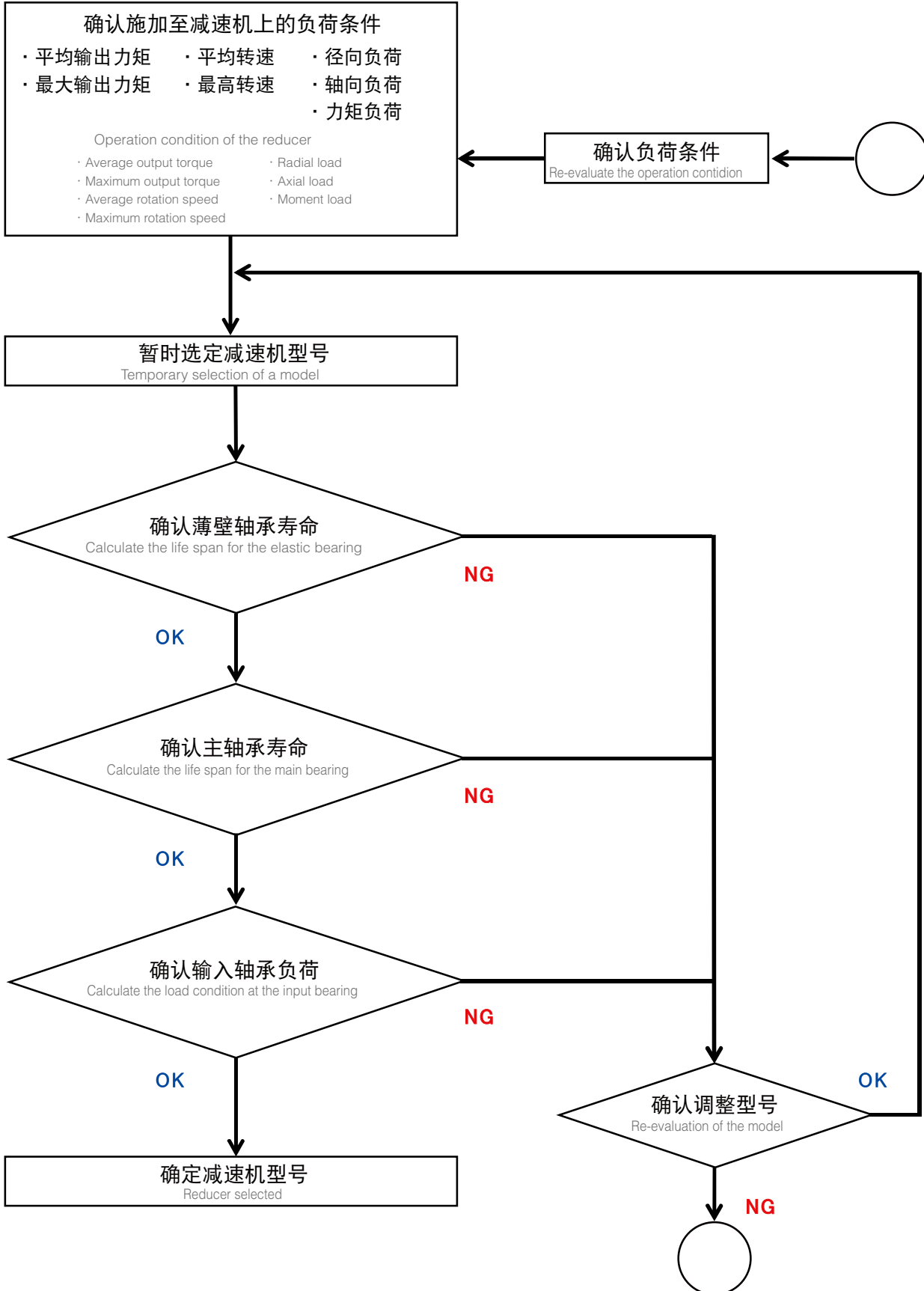

减速机型号 Reducer Model Nomenclature

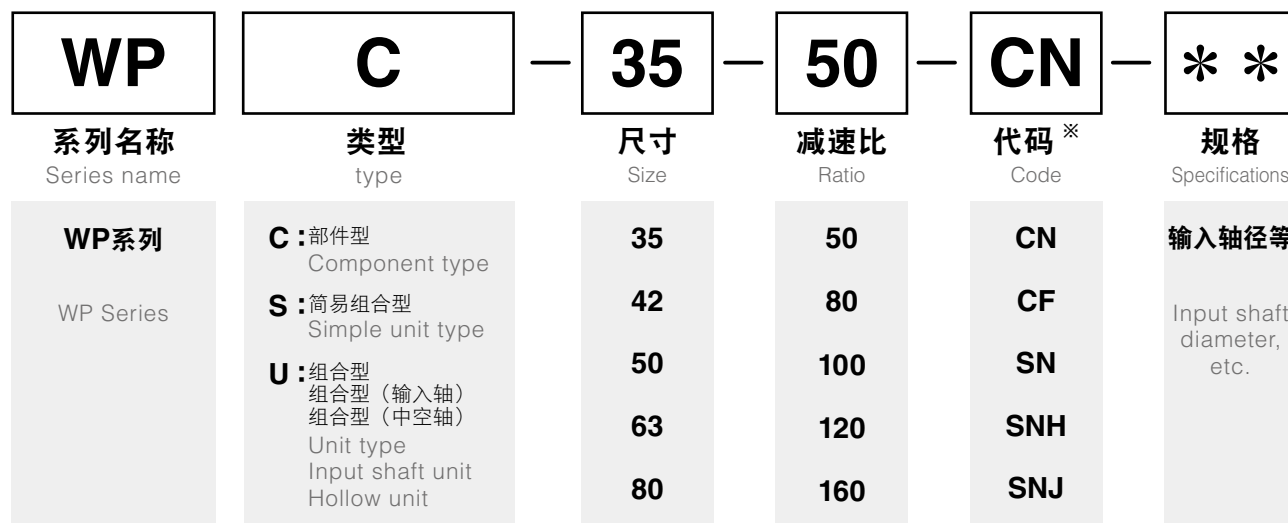

● 段位表 Availability

Ratio matrix

尺寸 \ 减速比	50	80	100	120	160
35					
42					
50					
63					
80					

※代码详情请参照尺寸表。

For the code details, please check the Dimensions Table.

减速机规格 Reducer Specifications

尺寸 Size	减速比 Ratio R ^{*1}	※2	※3	※4	※5	※6	※7
		容许平均力矩 Nominal output torque [Nm]	容许最大力矩 Maximum output torque [Nm]	紧急最大力矩 Emergency stop torque [Nm]	容许平均输入转速 Nominal input speed [r/min]	容许最高输入转速 Maximum input speed [r/min]	寿命时间 Life [hours]
35	50	7	23	46	3000	8500	7000
	80	9	27	55			
	100	9	32	63			
42	50	21	44	91	3000	7300	
	80	26	50	102			
	100	28	63	129			
	120	28	63	129			
50	50	33	73	127	3000	6500	
	80	40	86	149			
	100	47	96	172			
	120	47	96	172			
63	50	51	127	242	3000	5600	
	80	66	142	266			
	100	70	163	295			
	120	70	163	295			
80	50	89	253	447	3000	4800	
	80	122	316	590			
	100	142	346	673			
	120	142	346	673			
	160	142	346	673			

※1 请将R值代入P.4所述公式内，求得减速比

※2 输入转速为2000r/min时的容许最大值

※3 启动、停止时的容许最大值

※4 发生撞击时的容许最大值

※5 运转过程中，平均输入转速的容许最大值

※6 运转过程中，输入转速的容许最大值

※7 输入转速2000r/min，容许额定力矩负荷时的寿命时间

*1 Reduction ratio is to be calculated by the formula in the previous page, using R value in this table.

*2 The maximum allowable value at the input rotation speed of 2000r/min

*3 The maximum torque when starting and stopping.

*4 The maximum torque when it receives shock.

*5 The maximum average input speed.

*6 The maximum input speed.

*7 The life time at the input rotation speed of 2000 r/min and nominal output torque.

减速机型号 / Reducer Model / Specifications	尺寸表 Dimensions Table	寿命计算 (薄壁轴承) Life estimation (Elastic bearing)	寿命计算 (主轴承) Life estimation (Main bearing)	输入轴容许负荷 / 输入轴 / input shaft / lubricant information	输入轴容许负荷 / Maximum load at input shaft / lubricant information	安装精度 Attachment fixture requirement	传导力矩 Transmitting Torque	输入部位构造 / Input section structure/ Installation and assembly instructions	电机安装方法 Motor installation procedure	特性数据 Characteristics Data
--	-------------------------	--	--	--	--	---	-----------------------------	---	---	------------------------------

尺寸表 *Dimensions Table*

封闭型 部件型

Closed Type, Component

WPC-□ - □ -CN
WPC-□ - □ -CF

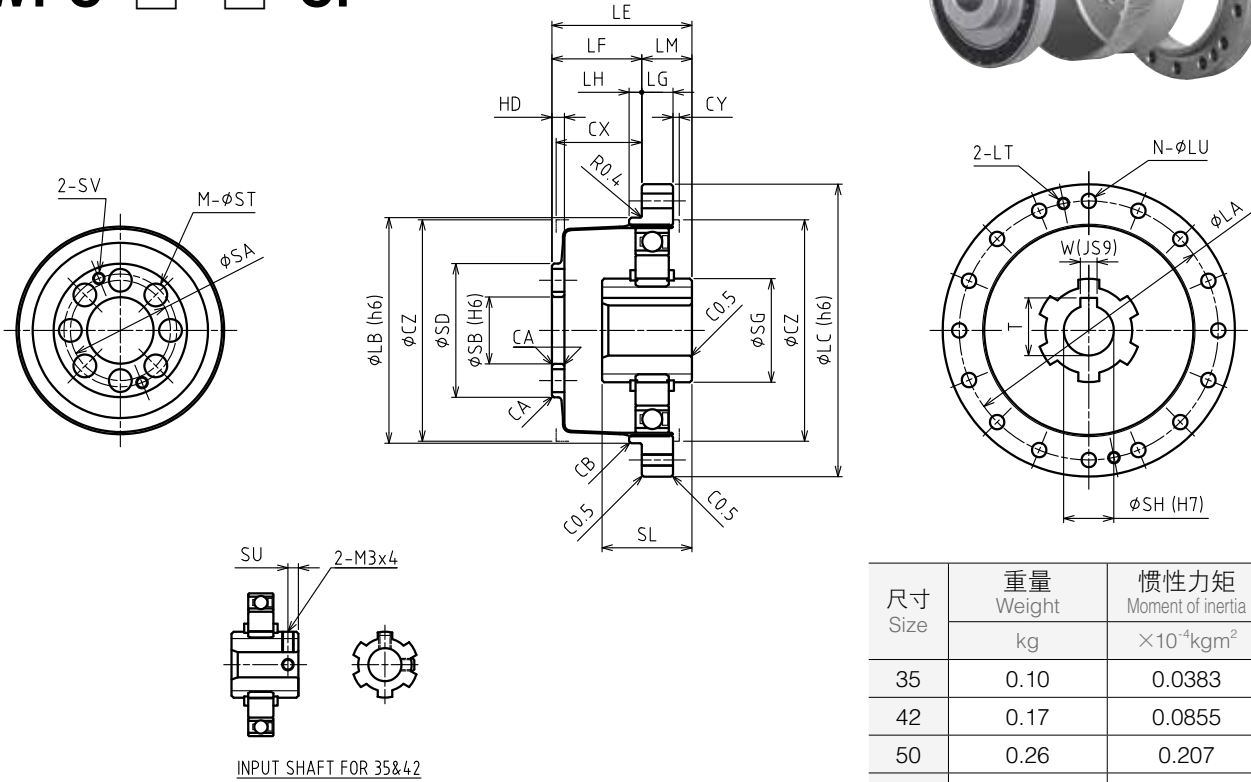

尺寸 Size	重量 Weight	惯性力矩 Moment of inertia
	kg	$\times 10^{-4} \text{kgm}^2$
35	0.10	0.0383
42	0.17	0.0855
50	0.26	0.207
63	0.43	0.544
80	0.91	1.63

[mm]

尺寸 Size	LA	LB	LC	N*1	LU	LT	LE	LF	LG	LH	LM	SG	SH	SL	W
35	44	38	50	8 (6)	3.5	M3	28.5	17.5	6	2	11	15.8	6	18.5	-
42	54	48	60	16(12)	3.5	M3	32.5	20	6.5	2.5	12.5	15.8	8	20.7	-
50	62	54	70	16(12)	3.5	M3	33.5	21.5	7.5	3	12	24.8	12	21.5	4
63	75	67	85	16(12)	4.5	M4	37	24	10	3	13	27.8	14	21.6	5
80	100	90	110	16(12)	5.5	M5	44	28	14	3	16	27.8	14	23.6	5

尺寸 Size	T	SU	SA	SB	SD	M	ST	SV	HD	CA	CB	CX	CY	CZ
35	-	2.5	17	11	23.5	6	4.5	M3	2.4	C0.5	C0.3	17	1	38
42	-	3	19	10	27	6	5.5	M3	3	C0.5	C0.3	19	1	45
50	13.8	-	24	16	32	8	5.5	M3	3	C0.5	C0.5	20.5	1.5	53
63	16.3	-	30	20	40	8	6.5	M4	3	C0.5	C0.5	23	1.5	66
80	16.3	-	40	26	52	8	8.8	M5	3.2	C0.5	C0.5	26.8	1.5	86

※1 -CN 及 -CF 中尺寸不同。() 内为 -CF 的数值。

※2 关于输入部位详情，请参照单独尺寸图。

※3 CX、CY、CZ 为护罩内壁建议尺寸。

*1 -CN and -CF are different in dimensions. The -CF value is shown in ().

*2 For details in the input section, please check the drawings.

*3 Inner dimensions of CX, CY, CZ are recommended dimensions.

封闭型 组合型
Closed Type, Unit

WPU-□-□-CN
WPU-□-□-CF

尺寸 Size	重量 Weight	惯性力矩 Moment of inertia
	kg	×10 ⁻⁴ kgm ²
35	0.50	0.0377
42	0.68	0.0856
50	0.95	0.207
63	1.5	0.544
80	3.3	1.63

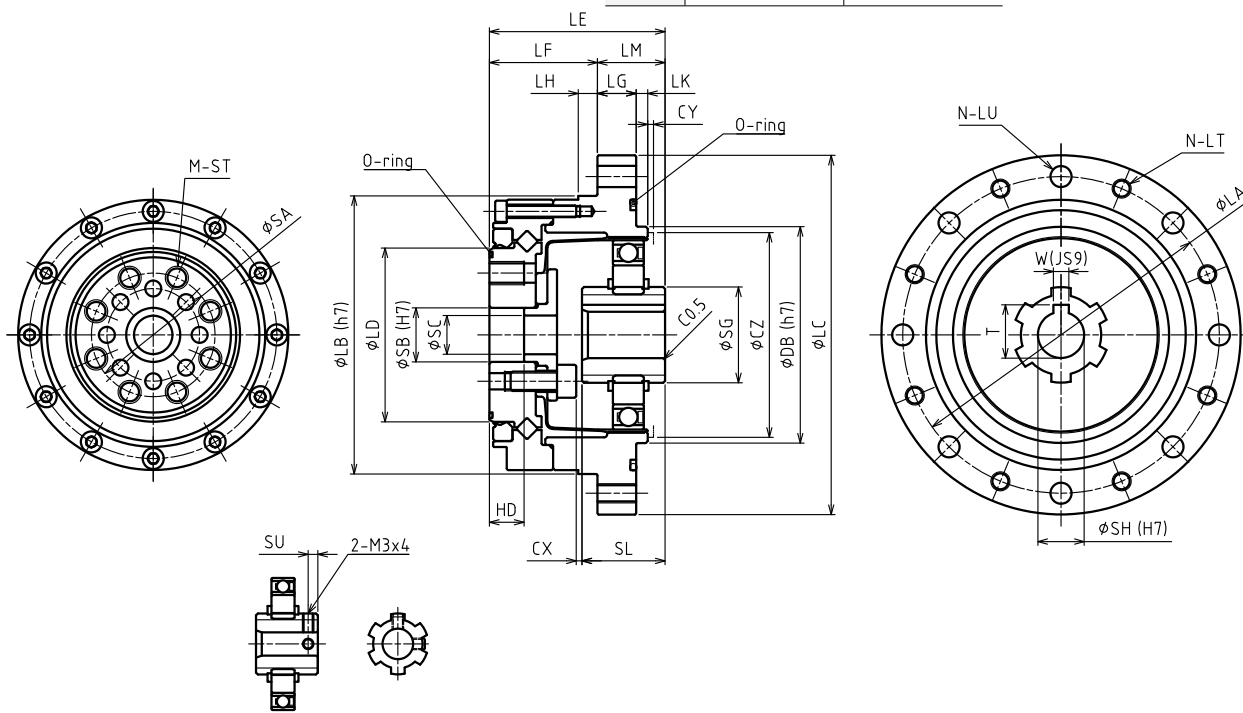

INPUT SHAFT FOR 35&42

[mm]

尺寸 Size	LA	LB	LC	LD	N ^{※1}	LT	LU	LE	LF	LG	LH	LK	LM	DB	SG
35	65	56	73	31	8 (6)	M4	4.5	41	27	7	3.5	2	14	38	15.8
42	71	63	79	38	8 (6)	M4	4.5	45	29	8	4	2	16	48	15.8
50	82	72	93	45	8 (6)	M5	5.5	45.5	28	10	5	3	17.5	56	24.8
63	96	86	107	58	10 (8)	M5	5.5	52	36	10	5	3	16	67	27.8
80	125	113	138	78	12	M6	6.5	62	45	12	5	3	17	90	27.8

尺寸 Size	SH	SL	W	T	SU	SA	SB	SC	M	ST	HD	CX	CY	CZ
35	6	18.5	-	-	2.5	23	11	8	6	M4 × 8	9.5	1.6	1	38
42	8	20.7	-	-	3	27	10	7	6	M5 × 8	9.5	1.3	1	45
50	12	21.5	4	13.8	-	32	14	10	8	M6 × 9	9	1.5	1.5	53
63	14	21.6	5	16.3	-	42	20	15	8	M8 × 10	12	3.4	1.5	66
80	14	23.6	5	16.3	-	55	26	20	8	M10 × 12	15	5.2	1.5	86

※1 -CN 及 -CF 中尺寸不同。() 内为 -CF 的数值。
※2 关于输入部位详情，请参照单独尺寸图。
※3 CY、CZ 为护罩内壁建议尺寸。

*1 -CN and -CF are different in dimensions. The -CF value is shown in ().
*2 For details in the input section, please check the drawings.
*3 Inner dimensions of CY, CZ are recommended dimensions.

尺寸表 *Dimensions Table*

开放型 简易组合型

Open type, Simple unit

WPS-□-□-**SN**

尺寸 Size	重量 Weight	惯性力矩 Moment of inertia
	kg	$\times 10^{-4} \text{kgm}^2$
35	0.39	0.0391
42	0.55	0.0870
50	0.79	0.209
63	1.3	0.549
80	2.7	1.65

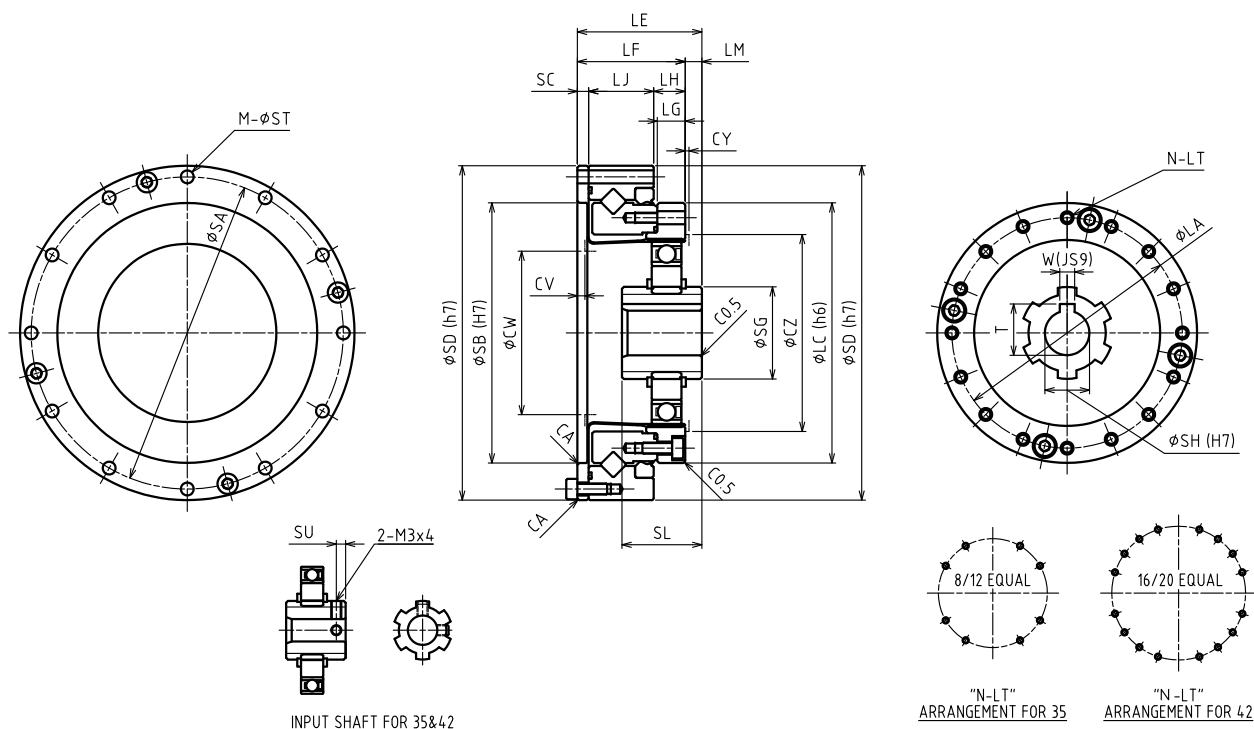

INPUT SHAFT FOR 35&42

"N-LT" ARRANGEMENT FOR 35

"N-LT" ARRANGEMENT FOR 42

[mm]

尺寸 Size	LA	LC	LE	LF	LG	LH	LJ	LM	SG	SH	SL	W	T	SU	SA	SB
35	44	50	28.5	23.5	6	7	14.1	5	15.8	6	18.5	-	-	2.5	64	48
42	54	60	32.5	26.5	6.5	7.5	16	6	15.8	8	20.7	-	-	3	74	60
50	62	70	33.5	29	7.5	8.5	17.5	4.5	24.8	12	21.5	4	13.8	-	84	70
63	77	85	37	34	10	12	18.7	3	27.8	14	21.6	5	16.3	-	102	88
80	100	110	44	42	14	15	23.4	2	27.8	14	23.6	5	16.3	-	132	114

尺寸 Size	SC	SD	M	ST	CA	CY	CZ	CV	CW	N	LT
35	2.4	70	8	3.5	C0.3	1	38	1.6	31	8	M3 × 5, φ 3.5 × 6
42	3	80	12	3.5	C0.3	1	45	2	37	16	M3 × 6, φ 3.5 × 6.5
50	3	90	12	3.5	C0.3	1.5	53	2	44	16	M3 × 6, φ 3.5 × 7.5
63	3.3	110	12	4.5	C0.3	1.5	66	2	56	16	M4 × 7, φ 4.5 × 10
80	3.6	142	12	5.5	C0.5	1.5	86	2	72	16	M5 × 8, φ 5.5 × 14

※1 关于输入部位详情, 请参照单独尺寸图。
 ※2 CV、CW、CY、CZ为护罩内壁建议尺寸。

*1 For details in the input section, please check the drawings.
 *2 Inner dimensions of CV, CW, CY, CZ are recommended dimensions.

开放型 组合型 (中空轴)
Open type, Unit (hollow shaft)

WPU- □ - □ -SNH

尺寸 Size	重量 Weight	惯性力矩 Moment of inertia
	kg	$\times 10^{-4} \text{kgm}^2$
35	0.57	0.103
42	0.79	0.230
50	1.1	0.460
63	1.7	1.24
80	3.4	3.18

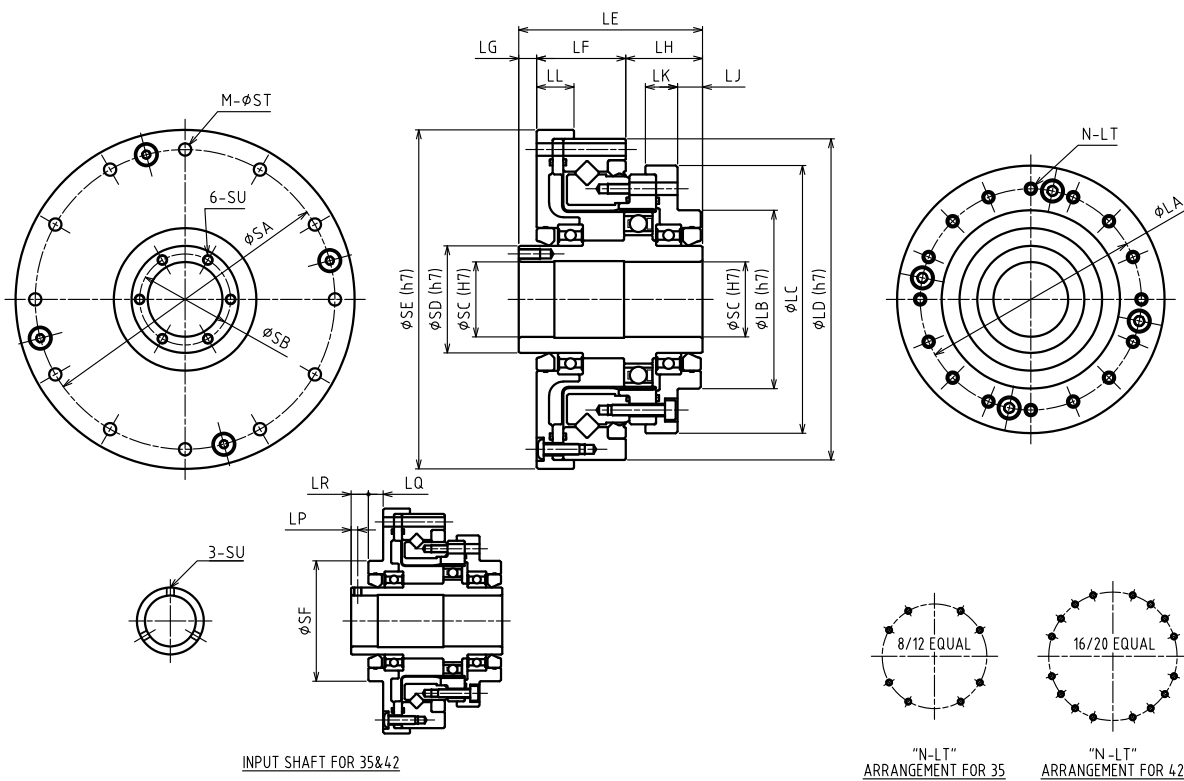

INPUT SHAFT FOR 35&42

"N-LT" ARRANGEMENT FOR 35

"N-LT" ARRANGEMENT FOR 42

[mm]

尺寸 Size	LA	LB	LC	LD	LE	LF	LG	LH	LJ	LK	LL	LP	LQ	LR
35	44	36	54	70	52.5	20.5	12	20	7.5	8	9	2.5	5.5	6.5
42	54	45	64	80	56.5	23	12	21.5	8.5	8.5	10	2.5	5.5	6.5
50	62	50	75	90	51.5	25	5	21.5	7	9	10.5	-	-	-
63	77	60	90	110	55.5	26	6	23.5	6	8.5	10.5	-	-	-
80	100	85	115	142	65.5	32	7	26.5	5	9.5	12	-	-	-

尺寸 Size	SA	SB	SC	SD	SE	SF	M	ST	SU	N	LT
35	64	-	14	20	74	36	8	3.5	M3	8	M3 × 5, φ 3.5 × 11.5
42	74	-	19	25	84	45	12	3.5	M3	16	M3 × 6, φ 3.5 × 12
50	84	25.5	21	30	95	-	12	3.5	M3 × 6	16	M3 × 6, φ 3.5 × 13.5
63	102	33.5	29	38	115	-	12	4.5	M3 × 6	16	M4 × 7, φ 4.5 × 15.5
80	132	40.5	36	45	147	-	12	5.5	M3 × 6	16	M5 × 8, φ 5.5 × 20.5

尺寸表 *Dimensions Table*

开放型 组合型 (输入轴)
Open type, Unit (input shaft)

WPU- □ - □ -SNJ

尺寸 Size	重量 Weight	惯性力矩 Moment of inertia
	kg	$\times 10^{-4} \text{kgm}^2$
35	0.48	0.0376
42	0.69	0.0897
50	1.0	0.208
63	1.6	0.554
80	3.2	1.74

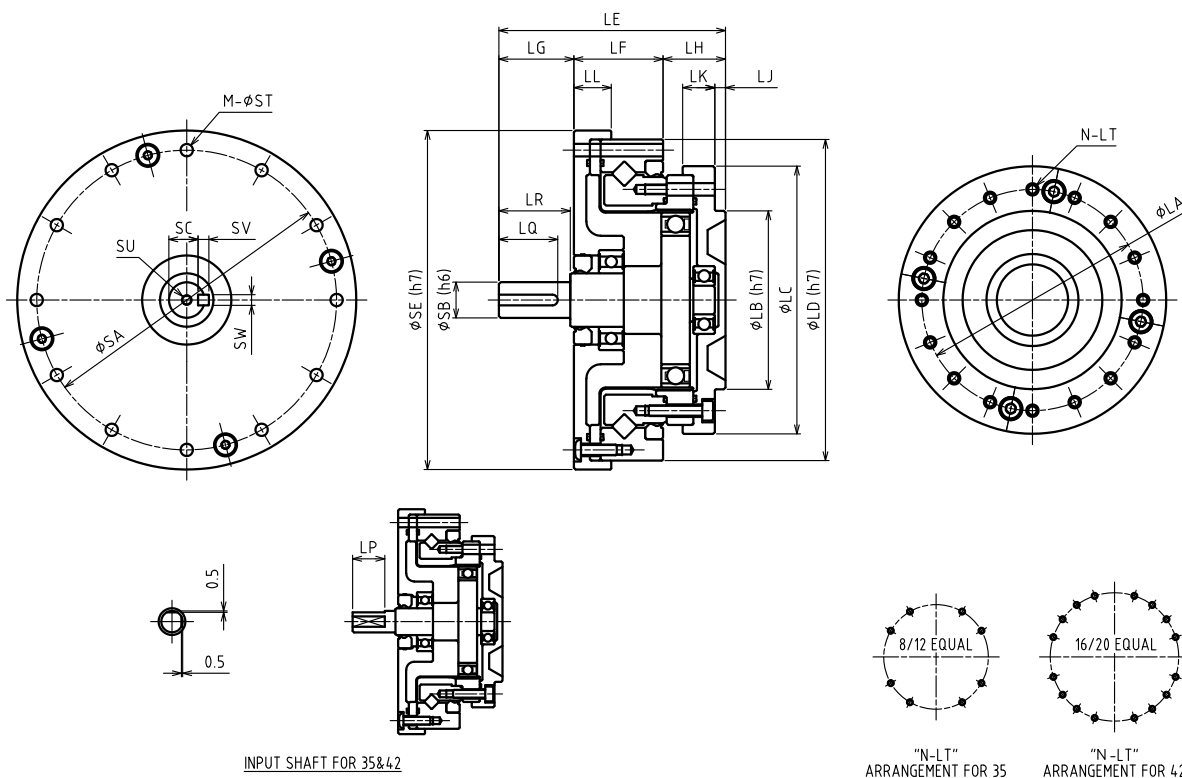

INPUT SHAFT FOR 35&42

"N-LT" ARRANGEMENT FOR 35

"N-LT" ARRANGEMENT FOR 42

[mm]

尺寸 Size	LA	LB	LC	LD	LE	LF	LG	LH	LJ	LK	LL	LP	LQ	LR
35	44	36	54	70	50.5	20.5	15	15	2.5	8	9	11	-	-
42	54	45	64	80	56	23	17	16	3	8.5	10	12	-	-
50	62	50	75	90	63.5	25	21	17.5	3	9	10.5	-	16.5	20
63	77	60	90	110	72.5	26	26	20.5	3	8.5	10.5	-	22.5	25
80	100	85	115	142	84.5	32	26	26.5	5	9.5	12	-	22.5	25

尺寸 Size	SA	SB	SC	SE	SV	SW	M	ST	SU	N	LT
35	64	6	-	74	-	-	8	3.5	-	8	M3 × 5, φ 3.5 × 11.5
42	74	8	-	84	-	-	12	3.5	-	16	M3 × 6, φ 3.5 × 12
50	84	10	8.2	95	3	3	12	3.5	M3 × 6	16	M3 × 6, φ 3.5 × 13.5
63	102	14	11	115	5	5	12	4.5	M5 × 6	16	M4 × 7, φ 4.5 × 15.5
80	132	14	11	147	5	5	12	5.5	M5 × 6	16	M5 × 8, φ 5.5 × 20.5

寿命计算（薄壁轴承） *Life estimation (Elastic bearing)*

薄壁轴承寿命计算

Life span for the elastic bearing

■ 运转类型

Operation cycle example

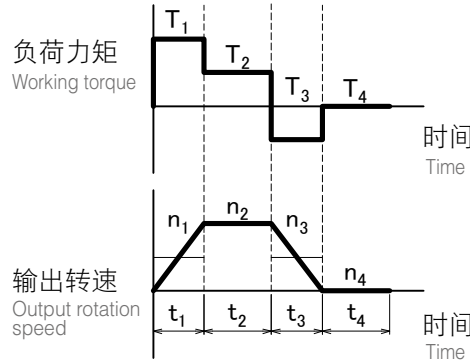

① 平均输出力矩 / 最大输出力矩的计算

Calculation formula for output torque

平均输出力矩 Average output torque	Tao	Nm	$Tao = \sqrt[3]{\frac{n_1 \cdot t_1 \cdot T_1 ^3 + n_2 \cdot t_2 \cdot T_2 ^3 + \dots + n_n \cdot t_n \cdot T_n ^3}{n_1 \cdot t_1 + n_2 \cdot t_2 + \dots + n_n \cdot t_n}}$
最大输出力矩 Peak output torque value	Tmo	Nm	$Tmo = T_1, T_2, \dots, T_n$ 的最大值 Tmo = Largest among T_1, T_2, \dots, T_n

请确认最大输出力矩为容许最大输出值以下

Please make sure the peak output torque is below the maximum output torque in the specification table

② 平均输入转速 / 最高输入转速的计算

Calculation formula for input speed

平均输出转速 Average output rotation speed	nao	r/min	$nao = \frac{n_1 \cdot t_1 + n_2 \cdot t_2 + \dots + n_n \cdot t_n}{t_1 + t_2 + \dots + t_n}$
最高输出转速 Peak output rotation speed	nmo	r/min	$nmo = n_1, n_2, \dots, n_n$ 的最大值 nmo = Largest among n_1, n_2, \dots, n_n
平均输入转速 Average input speed	nai	r/min	$nai = nao \times R$ (R = 减速比) (R = ratio)
最高输入转速 Peak input speed value	nmi	r/min	$nmi = nmo \times R$ (R = 减速比) (R = ratio)

请确认最高输入转速为容许最高输入转速值以下

Please make sure the peak input speed value is below the maximum input speed in the specification table

③ 寿命时间的计算

Calculation formula for life span

薄壁轴承寿命时间 Part life span for the elastic bearing	Lhe	h	$Lhe = 7000 \times \left(\frac{Tar}{Tao}\right)^3 \times \left(\frac{nar}{nai}\right)$
额定力矩 Rating torque	Tar	Nm	性能表中所记容许平均力矩 Nominal output torque in the specification table
额定输入转速 Rating input rotation speed	nar	r/min	2000 r/min

规格
Reducer Model / Specifications

尺寸表
Dimensions Table

寿命计算 (薄壁轴承)
Life estimation (Elastic bearing)

寿命计算 (主轴承)
Life estimation (Main bearing)

输入轴容许负荷 / 润滑油
Maximum load at input shaft / lubricant information

安装精度
Attachment fixture requirement

传导力矩
Transmitting Torque

输入部位构造 / 注意事项
Input section structure / Installation and assembly instructions

电机安装方法
Motor installation procedure

特性数据
Characteristics Data

寿命计算 (主轴承) *Life estimation(Main bearing)*

主轴承规格 (交叉滚子轴承) Main bearing specification(Cross roller bearing)

系列 Series	尺寸 Size	滚轴节圆直径 Pitch circle diameter of the bearing rollers	偏移量 Offset	基本动态额定负荷 Basic dynamic load rating	基本静态额定负荷 Basic static load rating	容许力矩 Allowable moment	力矩刚性 Moment rigidity
		Dm m	L m	C N	Co N	Mal Nm	Km ×10 ⁴ Nm/rad
WPU-□-□-CF WPU-□-□-CN	35	0.0335	0.0088	5620	6540	36.5	7.35
	42	0.0410	0.0098	6340	8170	55.8	8.02
	50	0.0485	0.0098	10400	13300	91.0	13.5
	63	0.0620	0.0108	15800	21100	156	27.7
	80	0.0815	0.0128	24400	35600	313	66.0
WPS-□-□-SN	35	0.0505	0.0162	7110	10200	74.0	14.4
	42	0.0598	0.0180	10900	15200	124	19.7
	50	0.0708	0.0194	17200	24700	187	40.1
	63	0.0856	0.0234	25100	37400	258	71.5
	80	0.114	0.0292	43300	67600	580	188
WPU-□-□-SNH WPU-□-□-SNJ	35	0.0505	0.0217	7110	10200	74.0	14.4
	42	0.0598	0.0235	10900	15200	124	19.7
	50	0.0708	0.0254	17200	24700	187	40.1
	63	0.0856	0.0289	25100	37400	258	71.5
	80	0.114	0.0357	43300	67600	580	188

主轴承寿命计算

Life span for the main bearing

运转类型

Operation cycle example

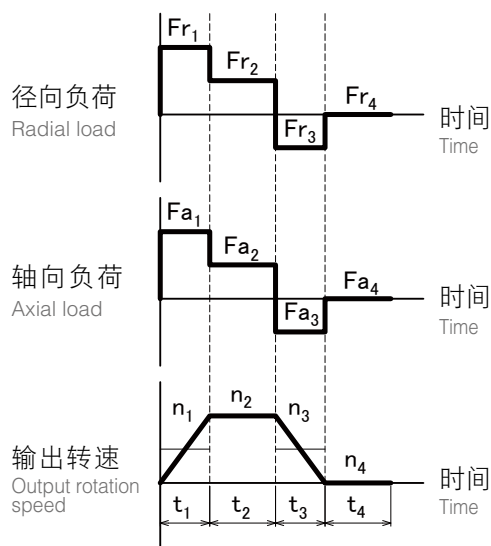

外部负荷

External load

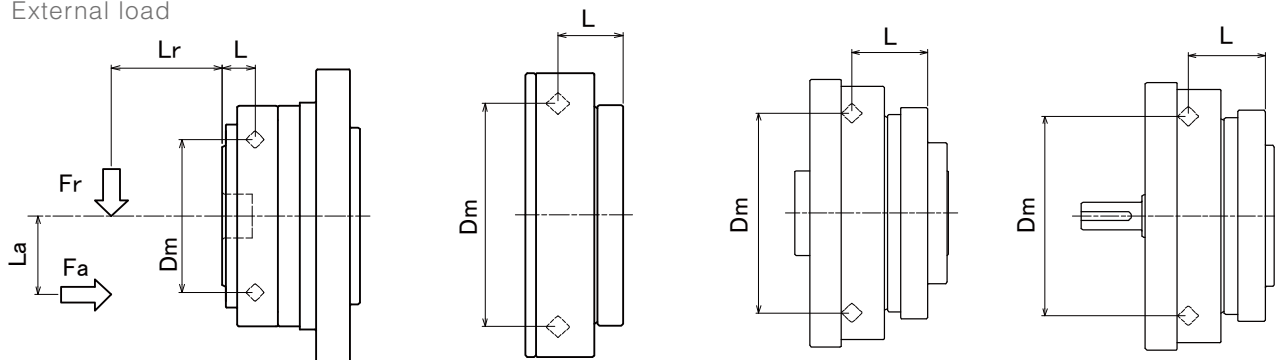

①最大负荷惯量的计算

Calculation formula for the largest working moment

最大负荷惯量 Peak working moment	Mm	Nm	$Mm = Frm \cdot (Lr + L) + Fam \cdot La$
最大径向负荷 Peak radial load	Frm	N	$Frm = Fr_1, Fr_2 \dots Fr_n$ 的最大值 Frm = Largest among $Fr_1, Fr_2, \dots Fr_n$
最大轴向负荷 Peak axial load	Fam	N	$Fam = Fa_1, Fa_2, \dots Fa_n$ 的最大值 Fam = Largest among $Fa_1, Fa_2, \dots Fa_n$

请确认最大负荷惯量为容许惯量值以下

Please make sure the peak working moment is below the maximum allowable moment

②平均径向负荷/ 轴向负荷/ 平均输出转速/ 平均负荷惯量的计算

Calculation formula for the Average radial load, Axial load, Average output rotation speed, Average working moment

平均径向负荷 Average radial load	Fra	N	$Fra = \sqrt[10]{\frac{n_1 \cdot t_1 \cdot Fr_1 ^{10/3} + n_2 \cdot t_2 \cdot Fr_2 ^{10/3} + \dots + n_n \cdot t_n \cdot Fr_n ^{10/3}}{n_1 \cdot t_1 + n_2 \cdot t_2 + \dots + n_n \cdot t_n}}$
平均轴向负荷 Axial load	Faa	N	$Faa = \sqrt[10]{\frac{n_1 \cdot t_1 \cdot Fa_1 ^{10/3} + n_2 \cdot t_2 \cdot Fa_2 ^{10/3} + \dots + n_n \cdot t_n \cdot Fa_n ^{10/3}}{n_1 \cdot t_1 + n_2 \cdot t_2 + \dots + n_n \cdot t_n}}$
平均输出转速 Average output rotation speed	nao	r/min	$nao = \frac{n_1 \cdot t_1 + n_2 \cdot t_2 \dots n_n \cdot t_n}{t_1 + t_2 + \dots + t_n}$
平均负荷惯量 Average working moment	Ma	Nm	$Ma = Fra \cdot (Lr + L) + Faa \cdot La$

③负荷系数/ 动态等价径向负荷的计算

Calculation formula for the Loading factor, Equivalent radial load

负荷系数 Loading factor	Xc, Yc	-	$\frac{Faa}{Fra + 2Ma / Dm} \leq 1.5$ 时, $Xc = 1.0, Yc = 0.45$
			$\frac{Faa}{Fra + 2Ma / Dm} > 1.5$ 时, $Xc = 0.67, Yc = 0.67$
动态等价径向负荷 Equivalent radial load	Pc	N	$Pc = Xc \cdot (Fra + 2Ma/Dm) + Yc \cdot Faa$

④主轴承寿命时间的计算

Life span for the main bearing

主轴承寿命时间 Life span for the main bearing	Lhc	h	$Lhc = \frac{10^6}{60 \cdot nao} \cdot \left(\frac{C}{fw \cdot Pc} \right)^3$
冲击系数 Impact factor	f w	-	1.0 : 未伴随冲击时 no shock
			1.2 : 伴随些许冲击时 with some shock
			1.5 : 伴随振动冲击时 with shock and vibration

输入轴容许负荷 *Maximum load at input shaft*

■ 轴承规格（开放型，组合型） Bearing specification (Open type, Unit)

系列 Series	尺寸 Size	轴承 A Bearing A		轴承 B Bearing B		a	b
		基本动态额定负荷 Basic dynamic load rating	基本静态额定负荷 Basic static load rating	基本动态额定负荷 Basic dynamic load rating	基本静态额定负荷 Basic static load rating		
		C	Co	C	Co		
		N	N	N	N		
WPU-□-□-<i>SNH</i>	35	4000	2470	4000	2470	16	27
	42	4300	2950	4300	2950	16	31
	50	4500	3450	4500	3450	14.5	27.5
	63	4900	4350	4900	4350	15.5	30.8
	80	14100	10900	5350	5250	19	37.0
WPU-□-□-<i>SNJ</i>	35	2240	910	1080	430	24	21.5
	42	2700	1270	1610	710	27	23.5
	50	4350	2260	2240	910	31.5	26
	63	5600	2830	2700	1270	37.5	29
	80	9400	5000	4350	2260	39	38.5

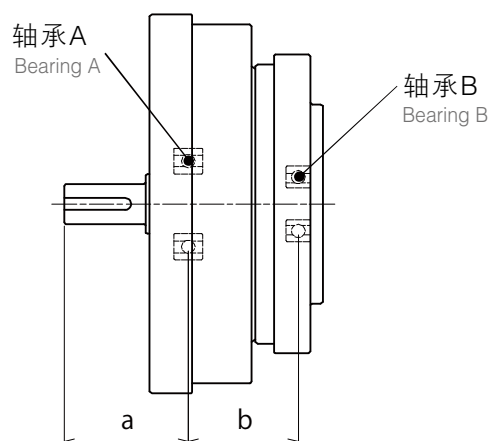
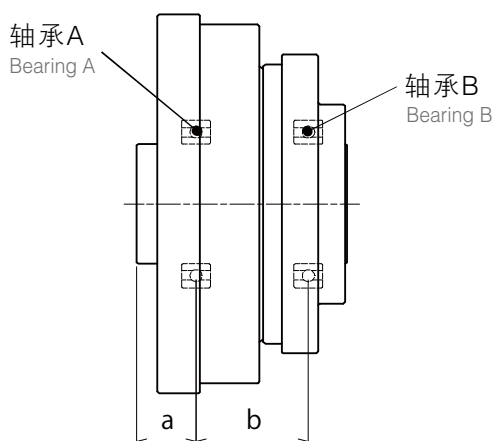

■ 容许负荷（平均输入转速：2000r/min、寿命时间：7000h）

Maximum load (Average input rotation speed : 2000r/min, Life span : 7000h)

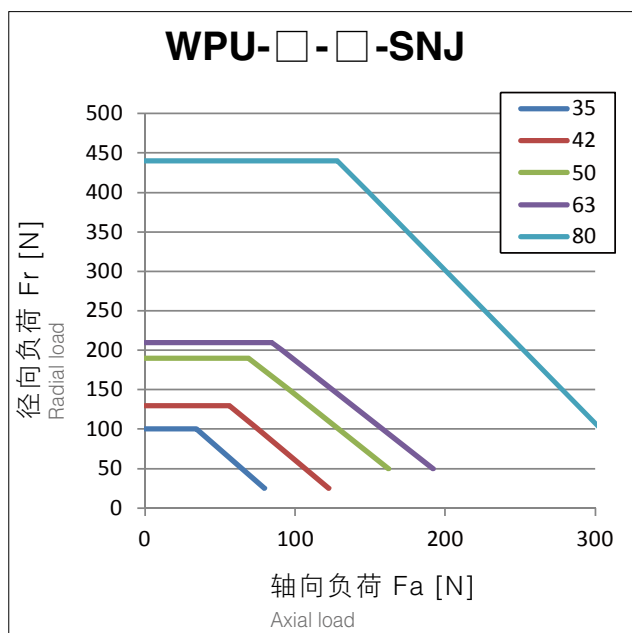
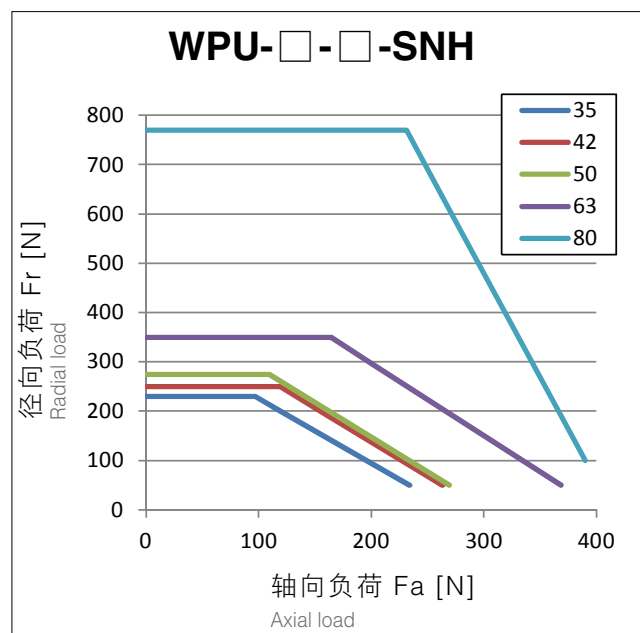

润滑剂 *lubricant information*

润滑剂的使用

Grease

Sumiplex MP No.2 (日本住矿润滑剂株式会社) Sumiplex MP No.2 (SUMICO LUBRICANT CO., LTD.)

使用温度范围: 0 ~ 40°C (环境温度) Operating temperature range: 0-40°C (ambient temperature)

润滑剂的涂抹

Grease application

按照以下要求在减速机各部位涂抹润滑剂。 Please apply grease according to the table below.

■ 润滑剂涂抹量 Grease application

- 根据减速机的安装方向（输出侧为横向、向上、向下）不同，变更涂抹部位C的涂抹量。（已封入润滑油的组合类型，填充了C（横向）的润滑油量。）
- 减速机为向上、向下时，请填写输入ASSY~护罩内壁空间的50%的润滑剂。
- 由于护罩设计造成润滑剂不足时，请咨询本公司。

The quantity of grease applied to C should be adjusted depending on the mounting direction. C of the unit type product is already filled with the same quantity of grease as horizontal mounting.

For vertical up/down, 50% of the space between input assy and casing inner wall should be filled with grease.

If the amount of grease is not sufficient due to case design, please contact us.

尺寸 Size	涂抹部位 Applied part					
	A	B	C (横向) Horizontal	C (向上) Vertical up	C (向下) Vertical down	D
35	0.3	0.3	6	8	9	0.3
42	0.5	0.5	10	12	14	0.5
50	0.8	0.8	16	18	21	0.8
63	1.5	1.5	30	35	40	1.5
80	3.0	3.0	60	70	80	3.0

■ 润滑剂涂抹部位 Grease application location

WPC-□-□-CF(CN)

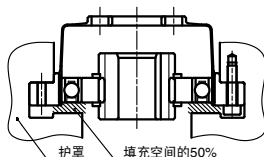
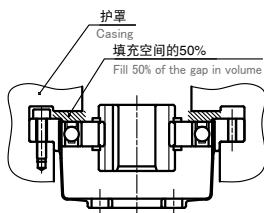
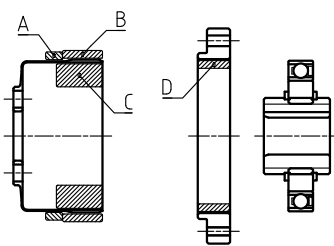

WPU-□-□-CF(CN)

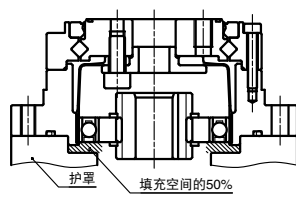
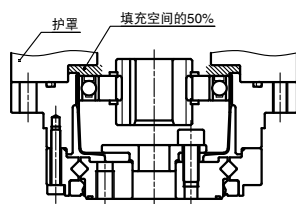
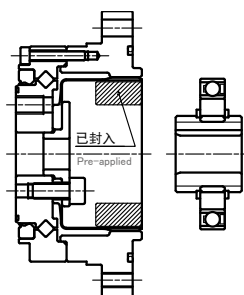

WPS-□-□-SN

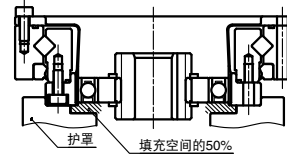
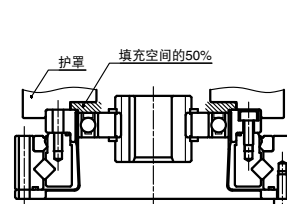
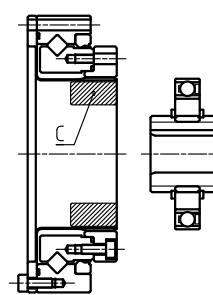

规格
Reducer Model / Specifications

尺寸表
Dimensions Table

寿命计算
(薄壁轴承)
Life estimation (Elastic bearing)

寿命计算
(主轴承)
Life estimation (Main bearing)

输入轴容许负荷 / 润滑剂
Maximum load at Input shaft / Lubricant information

安装精度
Attachment feature requirement

传力转矩
Transmitting Torque

输入部位构造 / 注意事项
Input section structure / Installation and assembly instructions

电机安装方法
Motor installation procedure

特性数据
Characteristics Data

安装精度 Attachment fixture requirement

■ 安装精度 Attachment fixture requirement

WPC-□-□-CF(CN)

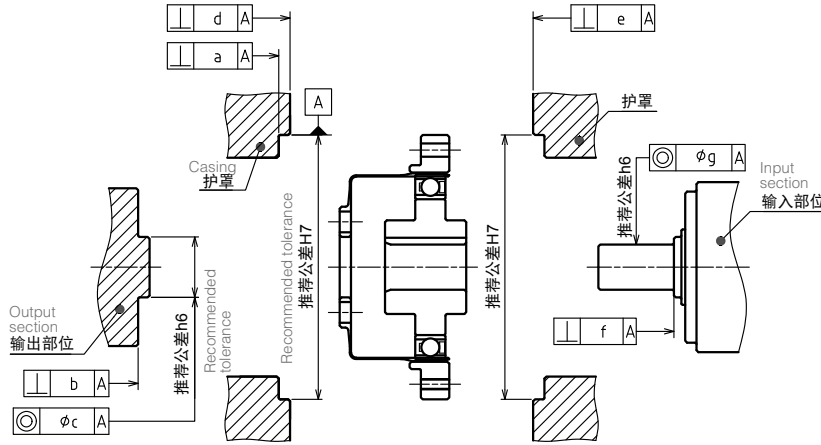

安装精度 [mm]

尺寸 Size	35	42	50	63	80
a	0.015	0.015	0.018	0.018	0.023
b	0.010	0.012	0.014	0.016	0.020
c	0.013	0.013	0.015	0.018	0.020
d	0.015	0.015	0.018	0.018	0.023
e	0.015	0.015	0.018	0.018	0.023
f	0.012	0.012	0.014	0.016	0.016
g	0.016	0.020	0.024	0.024	0.024

WPU-□-□-CF(CN)

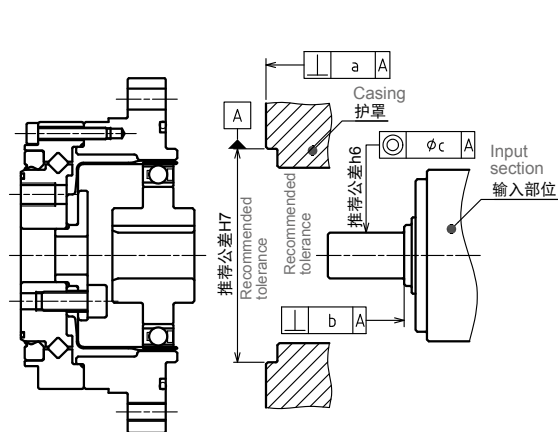

安装精度 [mm]

尺寸 Size	35	42	50	63	80
a	0.020	0.020	0.020	0.025	0.025
b	0.012	0.012	0.014	0.016	0.016
c	0.016	0.020	0.024	0.024	0.024

WPS-□-□-SN

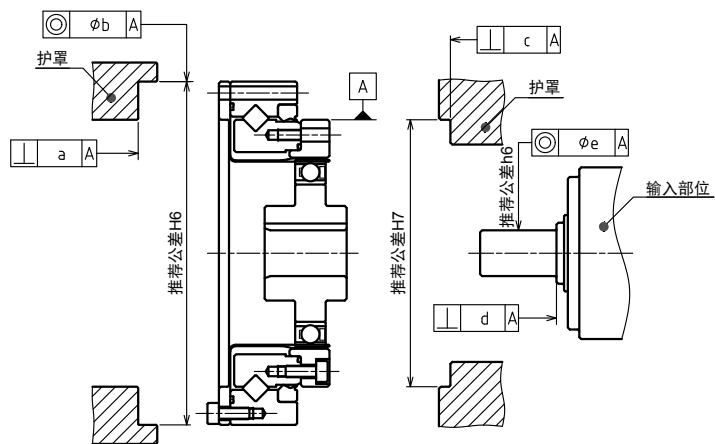

安装精度 [mm]

尺寸 Size	35	42	50	63	80
a	0.025	0.025	0.025	0.030	0.030
b	0.020	0.020	0.020	0.025	0.025
c	0.020	0.020	0.020	0.025	0.025
d	0.012	0.012	0.014	0.016	0.016
e	0.016	0.020	0.024	0.024	0.024

传导力矩 *Transmitting Torque*

安装螺丝

Bolting

螺丝紧固力矩如下表所示。

通过螺丝个数（因-CF、-CN而不同）及紧固力矩调整，可传导力矩存在差异，所以请注意确认。

Please refer to the table below for the bolt tightening torque.

Please be noted that the transmittable torque varies depending on the bolt count (different between CF and CN) and tightening torque.

螺丝紧固力矩

Tightening torque for bolts

螺丝尺寸	Bolt size	M3	M4	M5	M6	M8	M10
紧固力矩 [Nm]	Tightening torque	1.9	4.3	8.7	15	36	71

建议螺丝：强度区分12.9以上

Recommended bolt :
Strength rating above 12.9

传导力矩（封闭型、组合型）

Bolt specifications and Transmitting torque (Closed type, Unit)

安装输出法兰 Output flange attachment

尺寸	Size	35	42	50	63	80
螺丝尺寸	Bolt size	M4	M5	M6	M8	M10
螺丝个数	Bolt count	6	6	8	8	8
安装PCD [mm]	Bolt PCD	23	27	32	42	55
紧固力矩 [Nm]	Tightening torque	4.3	8.7	15	36	71
传导力矩 [Nm]	Transmitting torque	56	106	238	566	1177

安装内齿轮 (CN) Internal gear attachment

尺寸	Size	35	42	50	63	80
螺丝尺寸	Bolt size	M4	M4	M5	M5	M6
螺丝个数	Bolt count	8	8	8	10	12
安装PCD [mm]	Bolt PCD	65	71	82	96	125
紧固力矩 [Nm]	Tightening torque	4.3	4.3	8.7	8.7	15
传导力矩 [Nm]	Transmitting torque	210	230	430	629	1392

安装内齿轮 (CF) Internal gear attachment

尺寸	Size	35	42	50	63	80
螺丝尺寸	Bolt size	M4	M4	M5	M5	-
螺丝个数	Bolt count	6	6	6	8	-
安装PCD [mm]	Bolt PCD	65	71	82	96	-
紧固力矩 [Nm]	Tightening torque	4.3	4.3	8.7	8.7	-
传导力矩 [Nm]	Transmitting torque	158	172	322	503	-

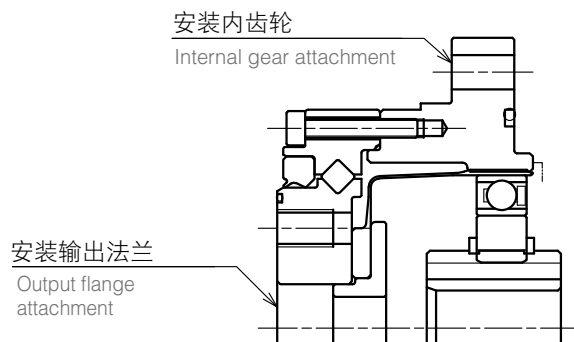

规格
Reducer Model /
Specifications

尺寸表
Dimensions Table

寿命计算
(薄壁轴承)
Life estimation
(Elastic bearing)

寿命计算
(主轴承)
Life estimation
(Main bearing)

输入轴容许负荷 /
润滑油
Maximum load at
input shaft/
lubricant information

安装精度
Attachment fixture
requirement

传导力矩
Transmitting Torque

输入部位构造 /
注意事项
Input section structure/
Installation and
assembly instructions

电机安装方法
Motor installation
procedure

特性数据
Characteristics Data

传导力矩 *Transmitting Torque*

传导力矩（封闭型、部件型）

Bolt specifications and Transmitting torque (Closed type, Component)

安装柔性齿轮 *Flex Gear Attachment*

尺寸	Size	35	42	50	63	80
螺丝尺寸	Bolt size	M4	M5	M5	M6	M8
螺丝个数	Bolt count	6	6	8	8	8
安装PCD [mm]	Bolt PCD	17	19	24	30	40
紧固力矩 [Nm]	Tightening torque	4.3	8.7	8.7	15	36
传导力矩 [Nm]	Transmitting torque	41	75	126	223	539

安装内齿轮 (CN) *Internal Gear Attachment*

尺寸	Size	35	42	50	63	80
螺丝尺寸	Bolt size	M3	M3	M3	M4	M5
螺丝个数	Bolt count	8	16	16	16	16
安装PCD [mm]	Bolt PCD	44	54	62	75	100
紧固力矩 [Nm]	Tightening torque	1.9	1.9	1.9	4.3	8.7
传导力矩 [Nm]	Transmitting torque	82	200	230	485	1048

安装内齿轮 (CF) *Internal Gear Attachment*

尺寸	Size	35	42	50	63	80
螺丝尺寸	Bolt size	M3	M3	M3	M4	M5
螺丝个数	Bolt count	6	12	12	12	12
安装PCD [mm]	Bolt PCD	44	54	62	75	100
紧固力矩 [Nm]	Tightening torque	1.9	1.9	1.9	4.3	8.7
传导力矩 [Nm]	Transmitting torque	61	150	172	364	786

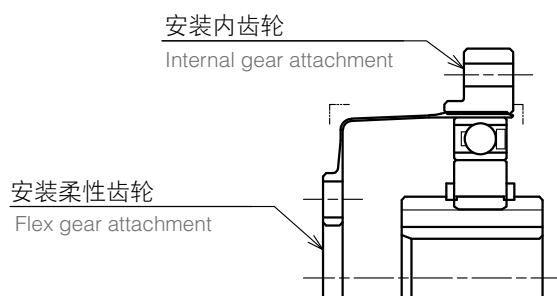

◆销子孔的追加 *Reinforcement*

柔性齿轮安装的传导力矩未满足要求时，请同时使用销子。
销子孔可根据需求追加。

Pins can be added if the transmittable torque at the flex gear interface is not sufficient.
As an option, holes can be added.

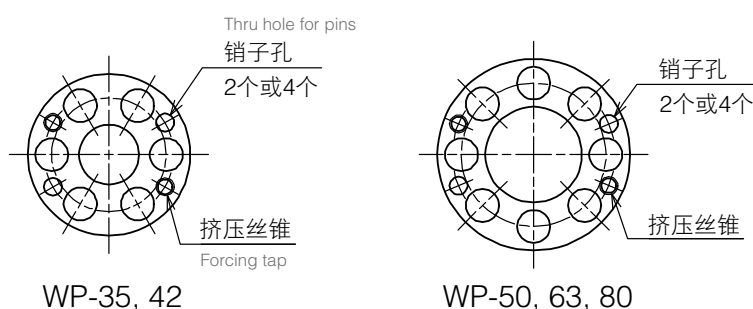

传导力矩（开放型）

Bolt specifications and Transmitting torque (Open type)

安装柔性齿轮 Flex Gear Attachment

尺寸	Size	35	42	50	63	80
螺丝尺寸	Bolt size	M3	M3	M3	M4	M5
螺丝个数	Bolt count	8	12	12	12	12
安装PCD [mm]	Bolt PCD	64	74	84	102	132
紧固力矩 [Nm]	Tightening torque	1.9	1.9	1.9	4.3	8.7
传导力矩 [Nm]	Transmitting torque	119	206	234	495	1037

安装内齿轮 Internal Gear Attachment

尺寸	Size	35	42	50	63	80
螺丝尺寸	Bolt size	M3	M3	M3	M4	M5
螺丝个数	Bolt count	8	16	16	16	16
安装PCD [mm]	Bolt PCD	44	54	62	77	100
紧固力矩 [Nm]	Tightening torque	1.9	1.9	1.9	4.3	8.7
传导力矩 [Nm]	Transmitting torque	82	200	230	498	1048

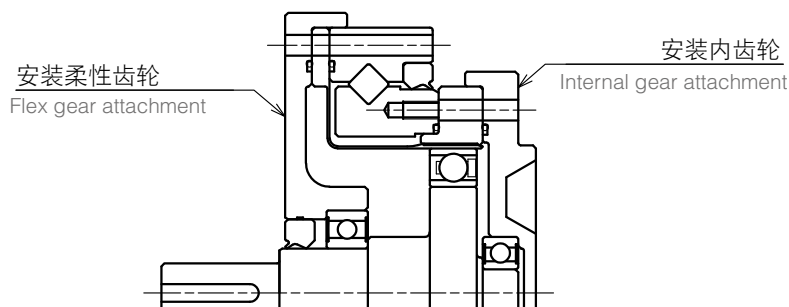
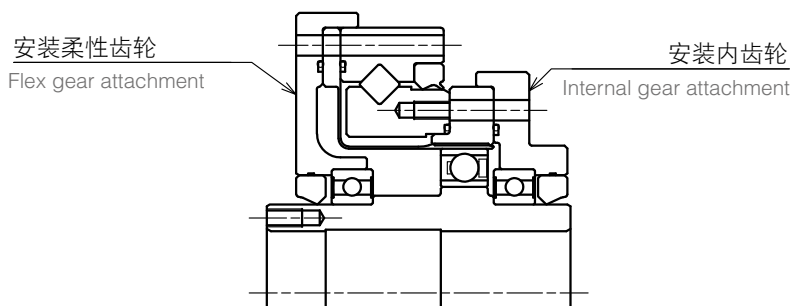
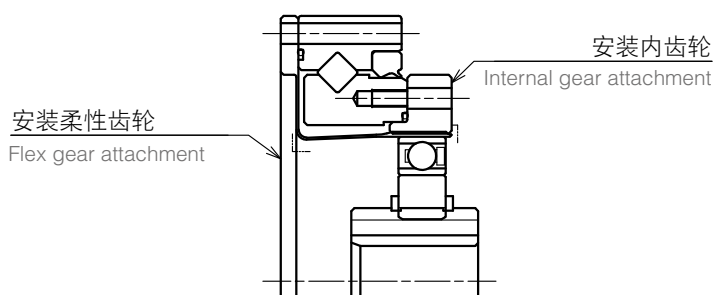

减速机型号 /
规格
Reducer Model /
Specifications

尺寸表
Dimensions Table

寿命计算
(薄壁轴承)
Life estimation
(Elastic bearing)

寿命计算
(主轴承)
Life estimation
(Main bearing)

输入轴容许负荷 /
润滑油
Maximum load at
input shaft/
lubricant information

安装精度
Attachment fixture
requirement

传导力矩
Transmitting Torque

输入部位构造 /
注意事项
Input section structure/
Installation and
assembly instructions

电机安装方法
Motor installation
procedure

特性数据
Characteristics Data

输入部位构造 *Input section structure*

输入部位构造

Input section structure

输入部位构造分为花键型（自动调心构造）与刚构型，因输入孔径等差异而不同。详细信息请确认尺寸图。

There are two types of input section structure, spline type (self-centering feature) and rigid type.

■ 花键型（自动调心构造）

Spline type (self-centering)

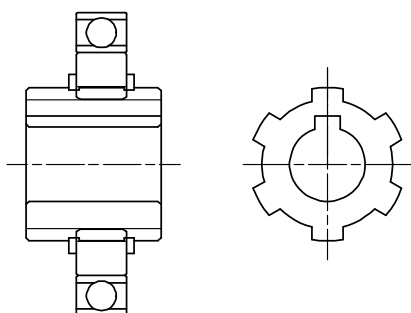

■ 刚构型

Rigid type

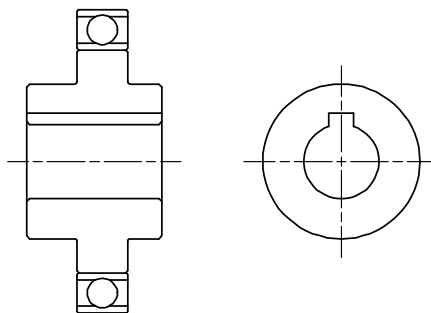

凸轮孔径尺寸

Cam hole diameter

凸轮孔径尺寸可变更。若在下表标准孔径尺寸以下时，则为花键型，在标准孔径～最大孔径范围，则为刚构型。若需下表范围以外尺寸，请另行咨询我公司。

The diameter of the cam opening is customizable. Holes smaller than the 'standard hole size' in the table will be built in the spline type. Holes equal to or larger than the 'standard hole size' and smaller than the 'maximum hole size' will be built in the rigid type. Please contact us if you need sizes outside the specification in the table.

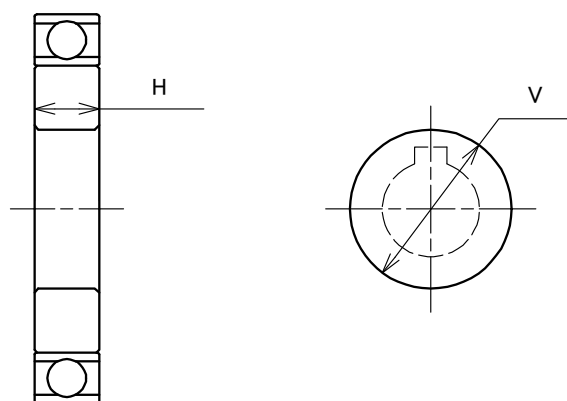

凸轮尺寸 Cam dimension

[mm]

尺寸 Size	35	42	50	63	80
标准孔径 standard bore size	6	8	12	14	14
最大孔径 V maximum bore size	17	20	23	28	36
最小厚度 H minimum thickness	6	7	8	9	11

注意事项 *Installation and assembly instructions*

输入/输出轴的支撑 (WPC-□-□-□)

Shaft installation instruction

输入轴 / 输出轴请采用承受作用于轴部的径向负荷 / 轴向负荷的支撑构造。(下图为参考实例) 来自减速机内部的轴向负荷作用于凸轮。请进行固定，避免凸轮发生轴向移动。

Please design the support structure for input shaft and output shaft so that both radial and axial loads are supported. (Diagram below shows an example)

Inside thrust load has effect on the cam. Secure cam from the possible axial movement.

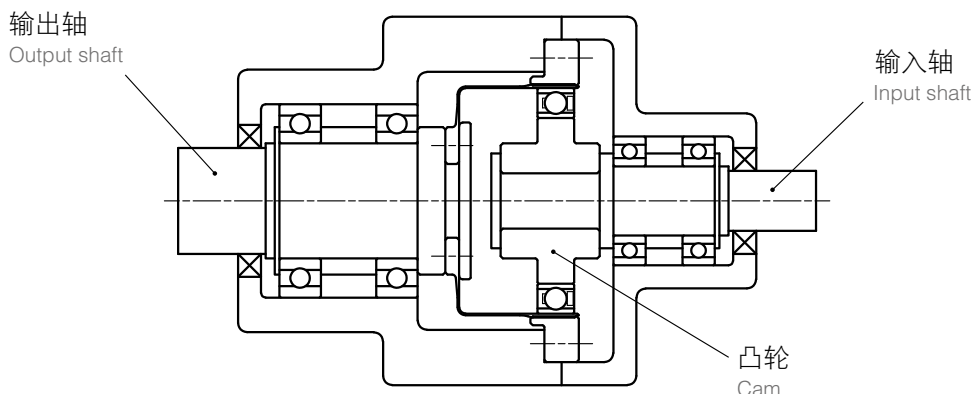

安装方法 (WPC-□-□-□)

Attachment flange requirement

安装与柔性齿轮相连接的法兰时，为了防止造成柔性齿轮破损，请保证下表所示尺寸。

For the attachment flange that comes in contact with flex gear, please build the corner radius according to the table below, in order to prevent damage.

	[mm]				
符号 Item	35	42	50	63	80
D	24.5	29	34	42	55
R	1.2	1.2	1.4	1.5	2
t	2	2.5	2.5	5	7

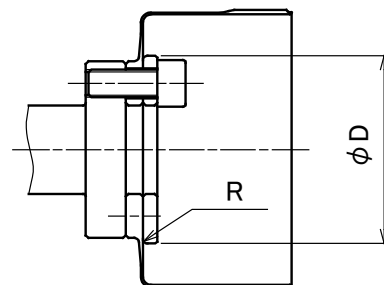

规格 Reducer Model / Specifications	减速机型号 / 规格	尺寸表 Dimensions Table	寿命计算 (薄壁轴承) Life estimation (Elastic bearing)	寿命计算 (主轴承) Life estimation (Main bearing)	输入轴容许负荷 / 润滑剂 Maximum load at input shaft/ lubricant information	安装精度 Attachment fixture requirement	传动力矩 Transmitting Torque	输入部位构造 / 注意事项 Input section structure/ Installation and assembly instruction	电机安装方法 Motor installation procedure	特性数据 Characteristics Data
---	---------------	-------------------------	--	--	--	---	-----------------------------	--	---	------------------------------

电机安装方法 *Motor installation procedure*

电机安装方法 (WPU-□-□-□)

Motor installation procedure

■ 安装步骤1

- 将法兰安装至电机上
- 将凸轮（轴承）安装至电机轴上
- 安装至组合型产品组件

Procedure 1

- Attach the flange on to the motor
- Attach the cam with elastic bearings to the motor shaft
- Attach the unit

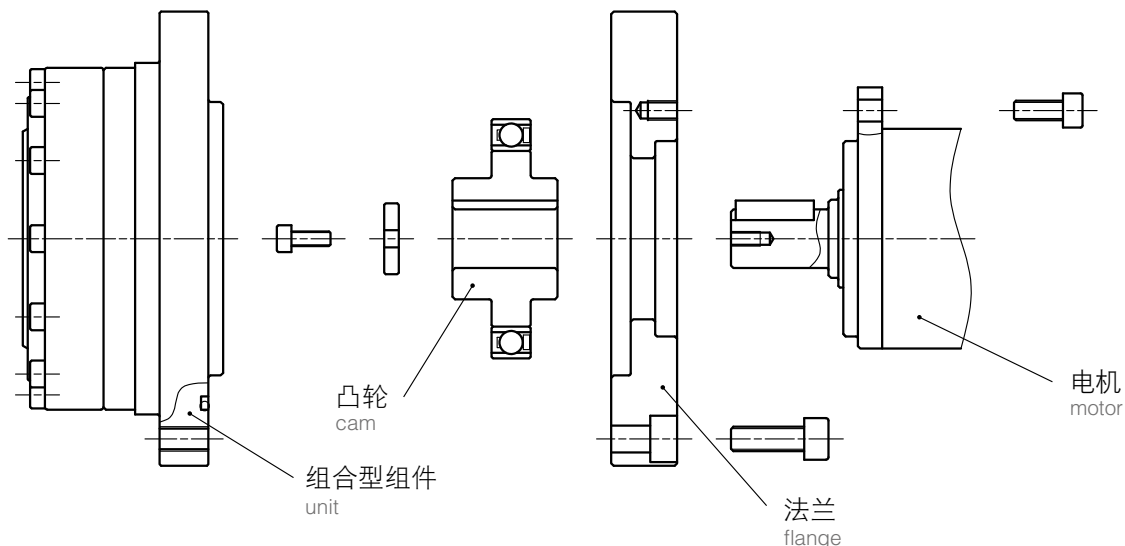

■ 安装步骤2

- 将凸轮（轴承）安装至电机轴上
- 将法兰安装至电机上
- 安装至组合型产品组件

Procedure 2

- Attach the cam with elastic bearings to the motor shaft
- Attach the flange on to the motor
- Attach the unit

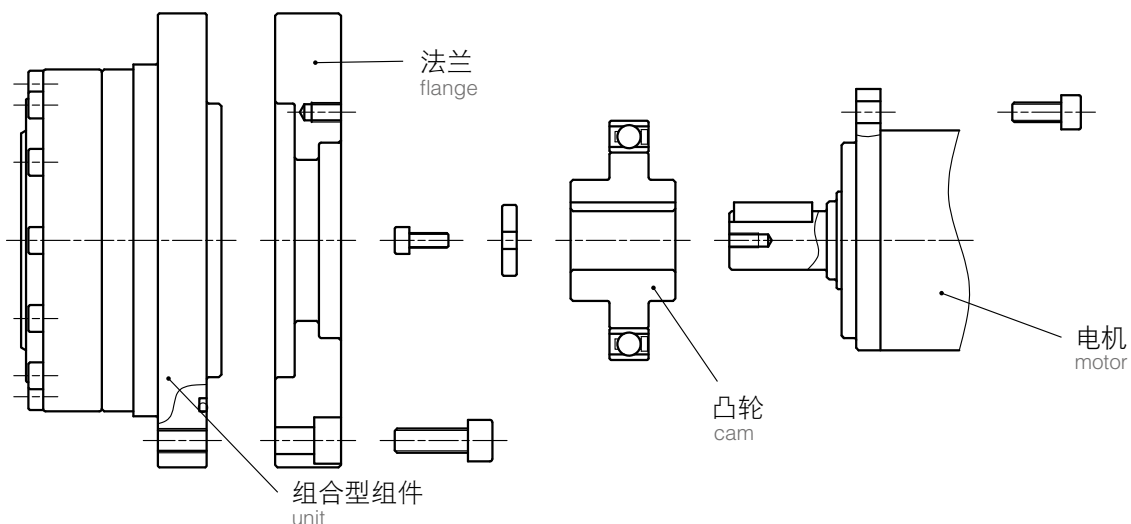

安装操作时的注意事项 *Caution during installation*

- 组装各零部件时，不可过度用力顶压。
- 注意不可倾斜插入输入 ASSY（凸轮、电机）。
- Do not use excessive force while mating parts
- Please watch for tilting during input section assembly (motor insertion into cam)

特性数据 Characteristics Data

角度传导精度

Transmission Angular Accuracy

角度传导精度定义

在无负荷条件下使输入轴旋转时，理论上输出旋转角度与实际输出旋转角度的差值。

What is Transmission Angular Accuracy?

It is the difference between the measured output rotation angle and the theoretical angle, while input shaft is rotated with no load.

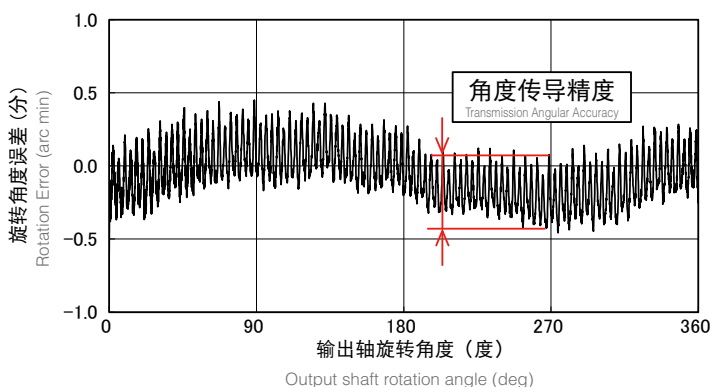

[arc min]

减速比 Ratio	尺寸 Size				
	35	42	50	63	80
50	2.0	2.0	1.5	1.0	1.0
80	1.5	1.5	1.0	1.0	1.0
100	1.5	1.5	1.0	1.0	1.0
120	-	1.5	1.0	1.0	1.0
160	-	-	1.0	1.0	1.0

※表中数值为参考值。

Table values are reference values.

滞后损失

Hysteresis Loss

滞后损失定义

输入侧固定后，将力矩施加至输出侧且0力矩时的扭曲角度差。

What is Hysteresis Loss?

When torque load is applied at the output shaft in alternate direction repeatedly with input shaft fixed, there is residual twisting angle when torque is back to zero.

In this context, hysteresis loss is the difference in the forward and backward twisting angle.

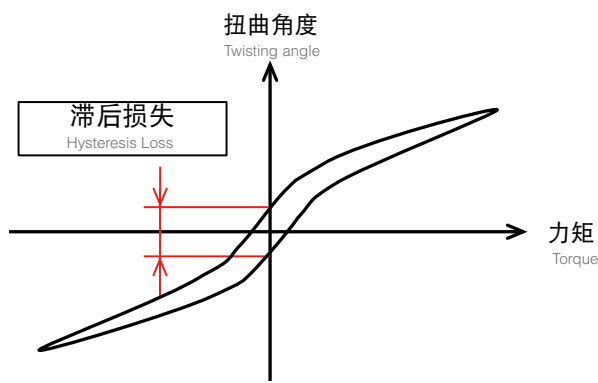

[arc min]

减速比 Ratio	尺寸 Size				
	35	42	50	63	80
50	2.0	2.0	2.0	2.0	2.0
80	1.5	1.5	1.0	1.0	1.0
100	1.5	1.5	1.0	1.0	1.0
120	-	1.5	1.0	1.0	1.0
160	-	-	1.0	1.0	1.0

规格
Reducer Model / Specifications

尺寸表
Dimensions Table

寿命计算
(薄壁轴承)
Life estimation (Elastic bearing)

寿命计算
(主轴承)
Life estimation (Main bearing)

输入轴容许负荷 / 润滑剂
Maximum load at input shaft / Lubricant information

安装精度
Attachment fixture requirement

传导力矩
Transmitting Torque

输入部位构造 / 注意事项
Input section structure / Installation and assembly instructions

电机安装方法
Motor Installation procedure

特性数据
Characteristics Data

特性数据 Characteristics Data

最大背隙

Maximum Backlash

[arc sec]

最大背隙定义

输入部采用花键型组件时的输出侧松动间隙
(齿轮相咬合部位背隙为0, 所以刚构型组件背隙为0)

What is Maximum Backlash?

In this context, maximum backlash is the output backlash for spline type input shaft. (Backlash is zero for rigid type input, because gear engagement backlash is zero.)

减速比 Ratio	尺寸 Size				
	35	42	50	63	80
50	27	27	18	16	16
80	17	17	11	10	10
100	13	13	9	8	8
120	-	11	7	7	7
160	-	-	6	5	5

刚性 (封闭型、组合型)

Stiffness (Closed type, Unit)

刚性定义

固定输入侧, 将力矩施加至输出侧时的弹簧常数与
扭曲角度

What is Stiffness?

In this context, stiffness is the output shaft twisting angle and the spring coefficient, while torque load is applied to the output shaft with input side fixed.

- K1...力矩 0 ~ T₁ 的弹簧常数
Spring coefficient at 0 ~ T₁ torque
- K2...力矩 T₁ ~ T₂ 的弹簧常数
Spring coefficient at T₁ ~ T₂ torque
- K3...力矩 T₂ ~ 的弹簧常数
Spring coefficient at T₂ ~ torque

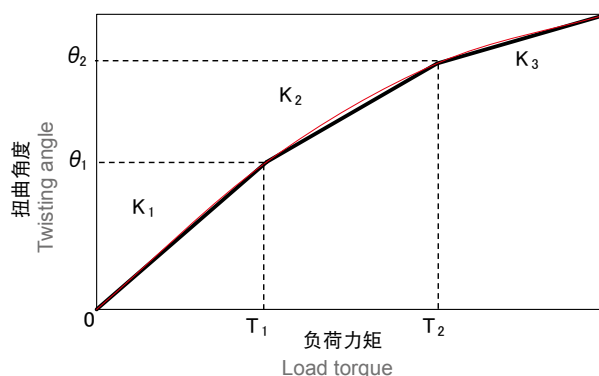

减速比 Ratio	符号 item	单位 unit	尺寸 Size				
			35	42	50	63	80
-	T ₁	Nm	2	3.9	7	14	29
-	T ₂	Nm	6.9	12	25	48	108
50	K ₁	× 10 ⁴ Nm/rad	0.28	0.69	1.1	2.7	5.6
	K ₂	× 10 ⁴ Nm/rad	0.45	0.85	1.7	3.3	7.1
	K ₃	× 10 ⁴ Nm/rad	0.55	1.1	2.5	4.0	8.3
	θ ₁	arcmin	2.3	2.2	2.0	1.8	2.0
	θ ₂	arcmin	5.7	4.5	5.3	5.5	6.5
80 100 120 160	K ₁	× 10 ⁴ Nm/rad	0.45	0.92	1.2	3.3	6.9
	K ₂	× 10 ⁴ Nm/rad	0.63	1.1	1.8	3.7	8.1
	K ₃	× 10 ⁴ Nm/rad	0.70	1.3	2.2	4.5	10
	θ ₁	arcmin	1.8	1.3	1.8	1.6	1.7
	θ ₂	arcmin	4.7	3.5	4.8	4.4	4.9

※表中数值为平均值。
Average value shown in the table

启动力矩

(封闭型, 组合型)

Starting Torque
(Closed type, Unit)

启动力矩定义

由输入侧使其旋转时, 输入侧开始旋转的力矩。

(无负荷, 环境温度: 25°C)

What is Starting Torque?

Input torque needed for input side to start rotating (no load, ambient temperature : 25°C)

加速启动力矩

(封闭型, 组合型)

Output Starting Torque
(Closed type, Unit)

加速启动力矩定义

由输出侧使其旋转时, 输出侧开始旋转的力矩。

(无负荷, 环境温度: 25°C)

What is Output Starting Torque?

Output torque needed for output side to start rotating (no load, ambient temperature : 25°C)

[cNm]

减速比 Ratio	尺寸 Size				
	35	42	50	63	80
50	1.7	3.9	5.5	8.7	19
80	1.9	4.2	6.0	9.5	21
100	1.6	3.5	5.0	7.9	18
120	-	2.8	4.0	6.3	14
160	-	-	3.6	5.8	13

※1 根据使用条件不同, 数值存在差异, 所以上表作为参考值使用。

※2 不包括输入侧油封及球形轴承等的旋转阻力所带来的影响。

*1 For reference only. Torque value may vary depending on the condition.

*2 Charts does not show effects due to rotation resistance of bearings and oil seals on the input side.

[Nm]

减速比 Ratio	尺寸 Size				
	35	42	50	63	80
50	1.3	2.6	4.5	5.7	12
80	1.9	4.0	6.8	8.6	19
100	2.1	4.4	7.5	9.5	21
120	-	5.3	9.0	11	25
160	-	-	9.9	13	29

※1 根据使用条件不同, 数值存在差异, 所以上表作为参考值使用。

※2 不包括输入侧油封及球形轴承等的旋转阻力所带来的影响。

*1 For reference only. Torque value may vary depending on the condition.

*2 Charts does not show effects due to rotation resistance of bearings and oil seals on the input side.

规格
Reducer Model /
Specifications

尺寸表
Dimensions Table

寿命计算
(薄壁轴承)
Life estimation
(Elastic bearing)

寿命计算
(主轴承)
Life estimation
(Main bearing)

输入轴容许负荷
/ 润滑油
Maximum load at
input shaft/
lubricant information

安装精度
Attachment fixture
requirement

传动力矩
Transmitting Torque

输入部位构造
/ 注意事项
Input section structure/
Installation and
assembly instructions

电机安装方法
Motor installation
procedure

特性数据
Characteristics Data

特性数据 *Characteristics Data*

无负荷运转力矩

(封闭型, 组合型)

No-load Running Torque
(Closed type, Unit)

无负荷运转力矩定义

在无负荷条件下, 使其旋转所需必要的输入侧力矩。

(平均值, 环境温度: 25°C)

What is No-load Running Torque?

Input torque needed to keep it running with no load
(average value, ambient temperature : 25°C)

[cNm]

减速比 Ratio	符号	尺寸 Size				
		35	42	50	63	80
50	500r/min	3.1	5.1	11.2	13.7	26.1
	1000r/min	3.4	5.4	12.4	15.2	28.6
	2000r/min	3.6	5.9	13.6	16.9	31.3
	3500r/min	3.9	6.3	14.9	18.8	34.2
80	500r/min	4.3	7.7	8.4	15.6	28.6
	1000r/min	4.6	8.3	9.2	17.3	31.2
	2000r/min	5.0	8.9	10.1	19.2	34.2
	3500r/min	5.4	9.6	11.1	21.4	37.4
100	500r/min	2.9	7.4	9.5	14.2	22.5
	1000r/min	3.1	8.0	10.5	15.7	24.6
	2000r/min	3.3	8.6	11.5	17.5	26.9
	3500r/min	3.6	9.2	12.6	19.4	29.4
120	500r/min	-	6.1	9.2	12.4	26.3
	1000r/min	-	6.5	10.1	13.8	28.8
	2000r/min	-	7.0	11.1	15.3	31.5
	3500r/min	-	7.5	12.2	17.0	34.5
160	500r/min	-	-	8.0	13.9	29.1
	1000r/min	-	-	9.1	14.8	30.8
	2000r/min	-	-	10.3	16.2	33.1
	3500r/min	-	-	11.6	17.7	35.7

※1 根据使用条件不同, 数值存在差异, 所以上表作为参考值使用。

※2 不包括输入侧油封及球形轴承等的旋转阻力所带来的影响。

*1 For reference only. Torque value may vary depending on the condition.

*2 Charts does not show effects due to rotation resistance of bearings and oil seals on the input side.

效率 (封闭型, 组合型)

Efficiency (Closed type, Unit)

负荷[%] : 负荷力矩/容许平均力矩
环境温度 : 25°C

※1 图表为实测数据的平均值。

※2 不包括输入侧油封及球形轴承等的旋转阻力所带来的影响。

·Percentile Load (%) is equal to load torque divided by allowable average torque.
·Ambient temperature : 25°C

*1 These diagrams represent the average value of the actual measurement.

*2 Charts does not show effects due to rotation resistance of bearings and oil seals on the input side.

WPU-35-50

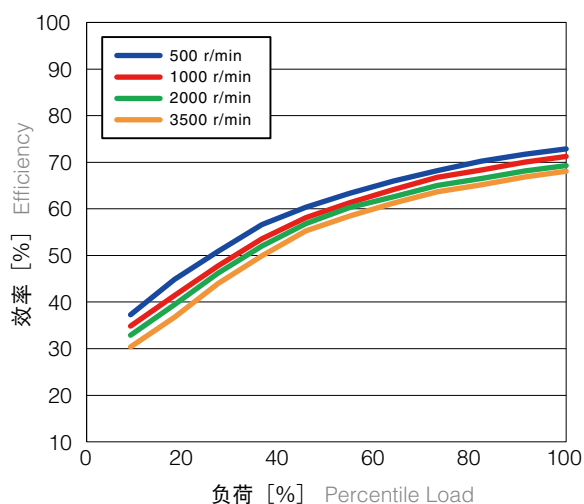

WPU-35-80

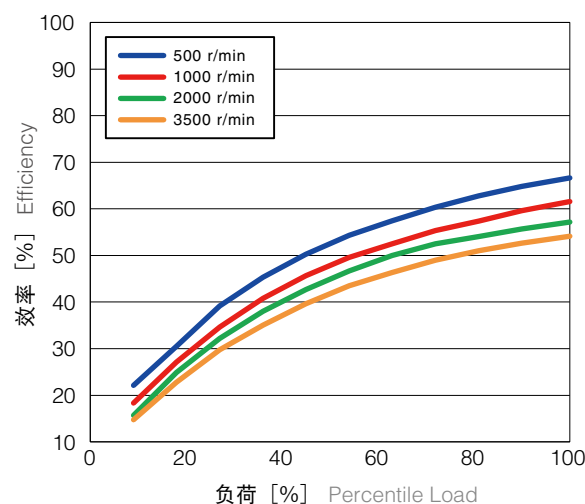

WPU-35-100

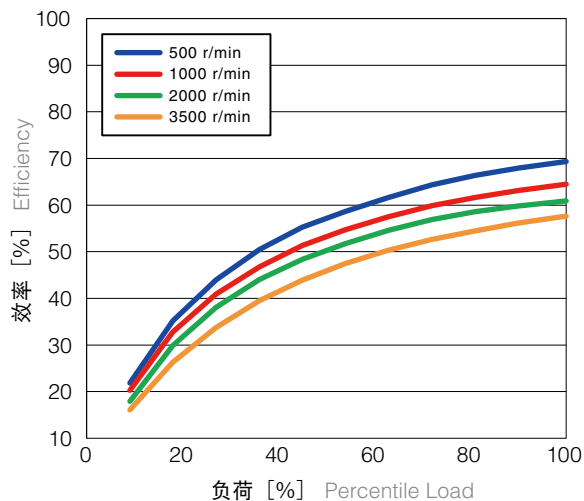

规格
Reducer Model /
Specifications

尺寸表
Dimensions Table

寿命计算
(薄壁轴承)
Life estimation
(Elastic bearing)

寿命计算
(主轴承)
Life estimation
(Main bearing)

输入轴容许负荷 /
润滑油
Maximum load at
input shaft/
lubricant information

安装精度
Attachment fixture
requirement

传力力矩
Transmitting Torque

输入部位构造 /
注意事项
Input section structure/
Installation and
assembly instructions

电机安装方法
Motor installation
procedure

特性数据
Characteristics Data

特性数据 *Characteristics Data*

效率 (封闭型, 组合型)

Efficiency (Closed type, Unit)

负荷[%] : 负荷力矩/容许平均力矩

环境温度: 25°C

※1 图表为实测数据的平均值。

※2 不包括输入侧油封及球形轴承等的旋转阻力所带来的影响。

·Percentile Load (%) is equal to load torque divided by allowable average torque.

·Ambient temperature : 25°C

*1 These diagrams represent the average value of the actual measurement.

*2 Charts does not show effects due to rotation resistance of bearings and oil seals on the input side.

WPU-42-50

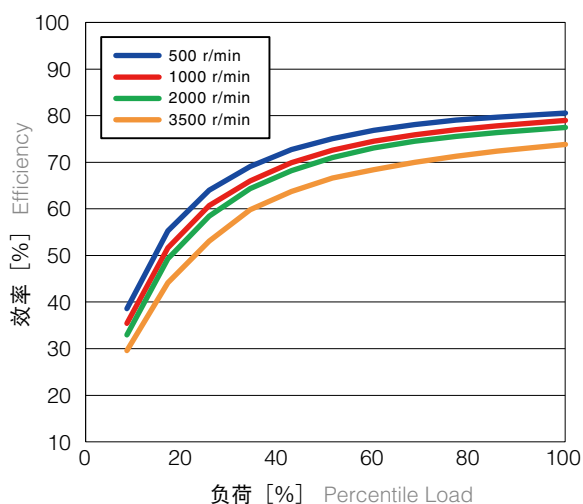

WPU-42-80

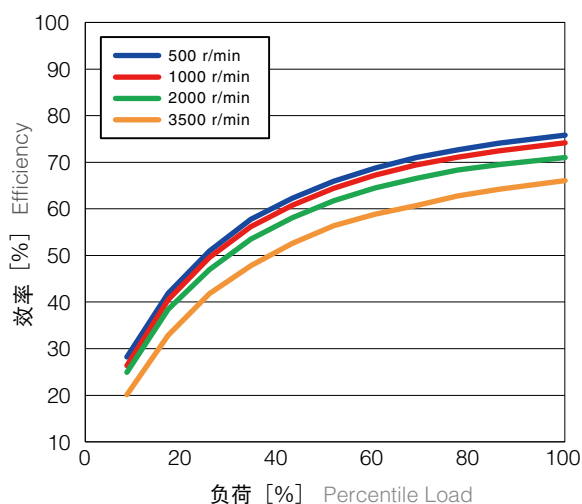

WPU-42-100

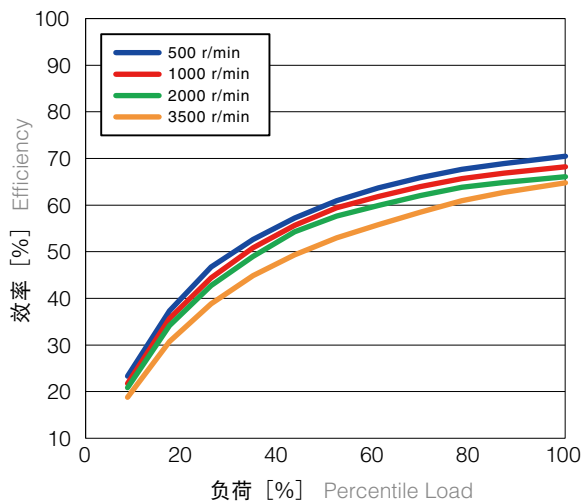

WPU-42-120

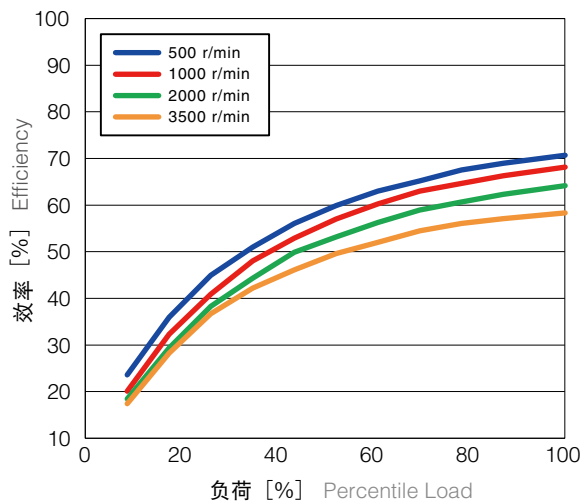

效率 (封闭型, 组合型)

Efficiency (Closed type, Unit)

负荷[%] : 负荷力矩/容许平均力矩
环境温度: 25°C

※1 图表为实测数据的平均值。

※2 不包括输入侧油封及球形轴承等的旋转阻力所带来的影响。

·Percentile Load (%) is equal to load torque divided by allowable average torque.

·Ambient temperature : 25°C

*1 These diagrams represent the average value of the actual measurement.

*2 Charts does not show effects due to rotation resistance of bearings and oil seals on the input side.

WPU-50-50

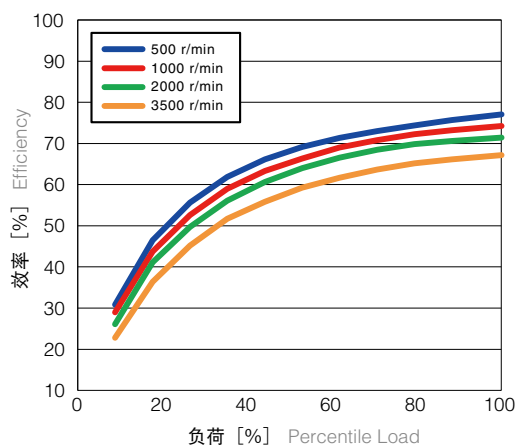

WPU-50-80

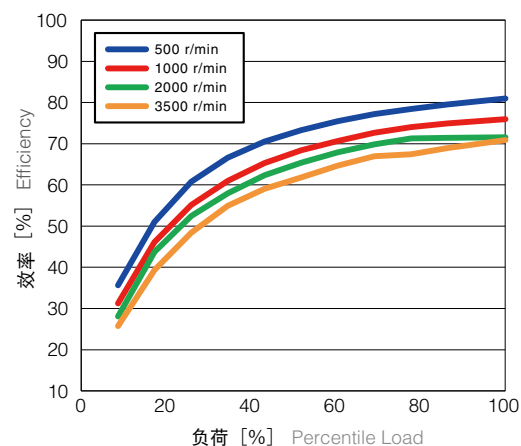

WPU-50-100

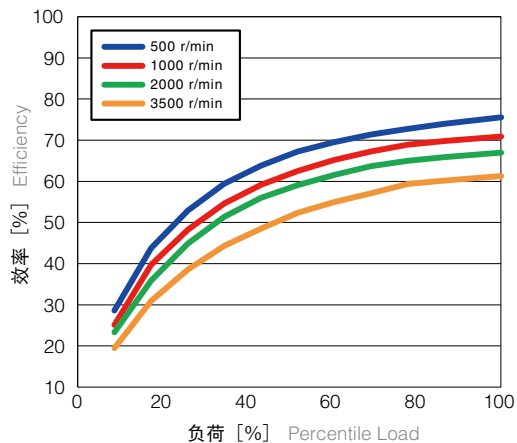

WPU-50-120

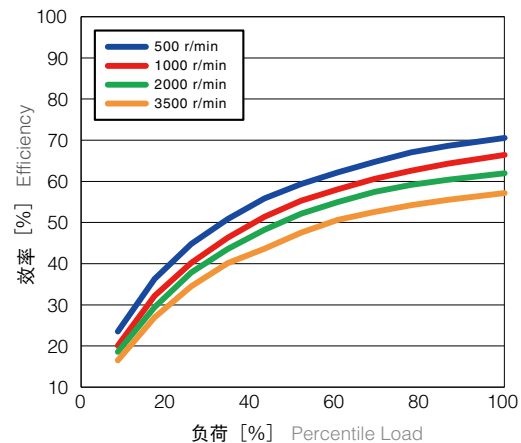

WPU-50-160

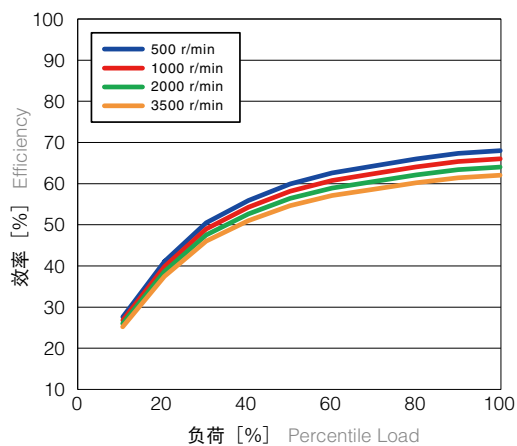

规格
Reducer Model / Specifications

尺寸表
Dimensions Table

寿命计算 (薄壁轴承)
Life estimation (Elastic bearing)

寿命计算 (主轴承)
Life estimation (Main bearing)

输入轴容许负荷 / 润滑油
Maximum load at input shaft / lubricant information

安装精度
Attachment fixture requirement

传导力矩
Transmitting Torque

输入部位构造 / 注意事项
Input section structure / Installation and assembly instructions

电机安装方法
Motor installation procedure

特性数据
Characteristics Data

特性数据 Characteristics Data

效率 (封闭型, 组合型)

Efficiency (Closed type, Unit)

负荷[%] : 负荷力矩/容许平均力矩

环境温度 : 25°C

※1 图表为实测数据的平均值。

※2 不包括输入侧油封及球形轴承等的旋转阻力所带来的影响。

·Percentile Load (%) is equal to load torque divided by allowable average torque.

·Ambient temperature : 25°C

*1 These diagrams represent the average value of the actual measurement.

*2 Charts does not show effects due to rotation resistance of bearings and oil seals on the input side.

WPU-63-50

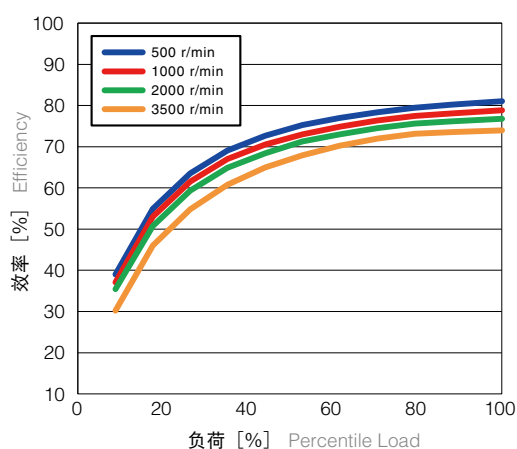

WPU-63-80

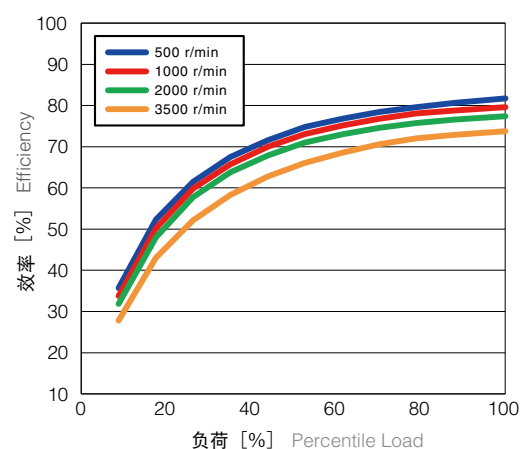

WPU-63-100

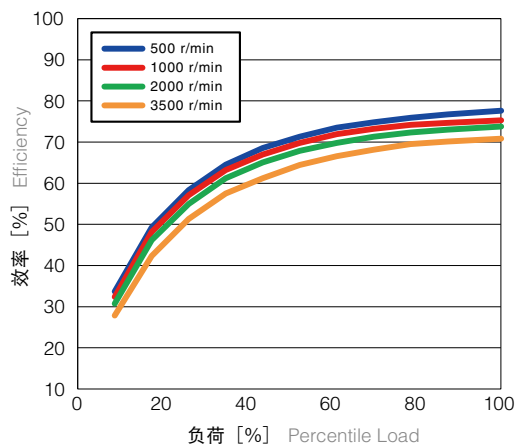

WPU-63-120

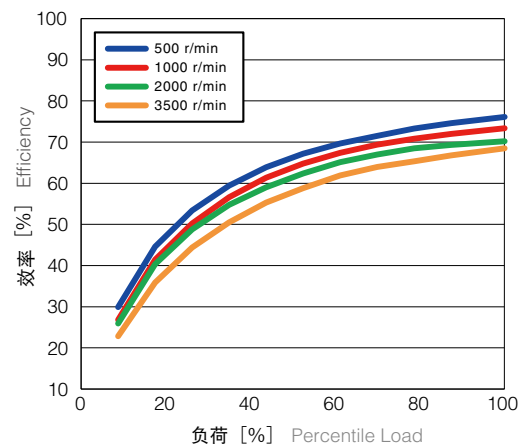

WPU-63-160

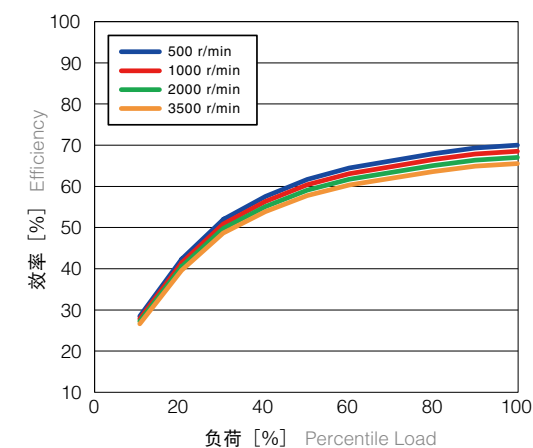

效率 (封闭型, 组合型)

Efficiency (Closed type, Unit)

负荷[%] : 负荷力矩/容许平均力矩

环境温度: 25°C

※1 图表为实测数据的平均值。

※2 不包括输入侧油封及球形轴承等的旋转阻力所带来的影响。

·Percentile Load (%) is equal to load torque divided by allowable average torque.

·Ambient temperature : 25°C

*1 These diagrams represent the average value of the actual measurement.

*2 Charts does not show effects due to rotation resistance of bearings and oil seals on the input side.

WPU-80-50

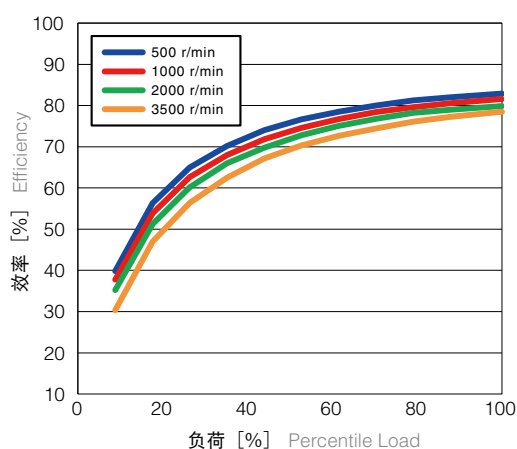

WPU-80-80

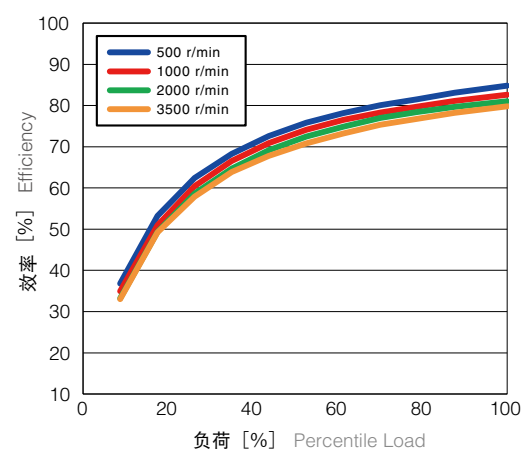

WPU-80-100

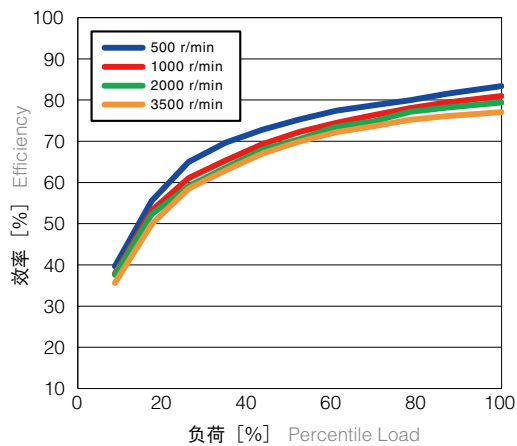

WPU-80-120

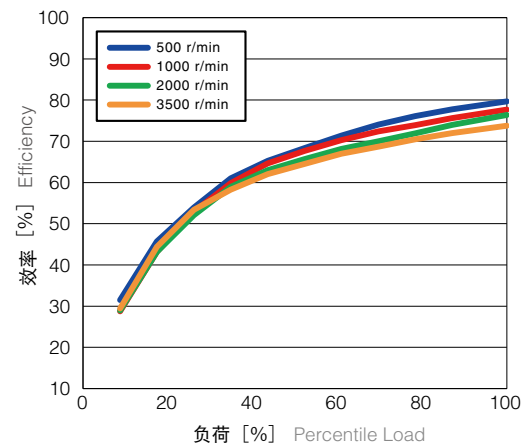

WPU-80-160

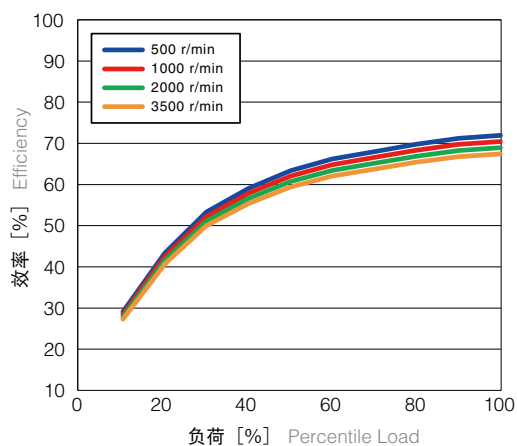

规格
Reducer Model / Specifications

尺寸表
Dimensions Table

寿命计算 (薄壁轴承)
Life estimation (Thin wall bearing)

寿命计算 (主轴承)
Life estimation (Main bearing)

输入轴容许负荷 / 润滑油
Maximum load at input shaft / Lubricant information

安装精度
Attachment fixture requirement

传力力矩
Transmitting Torque

输入部位构造 / 注意事项
Input section structure / Installation and assembly instructions

电机安装方法
Motor installation procedure

特性数据
Characteristics Data

减速机型号 Reducer Model Nomenclature

WP	C	35	50	CR	* *
系列名称 Series name	类型 type	尺寸 Size	减速比 Ratio	代码 ※ Code	规格 Specifications
WP系列 WP Series	C : 部件型 Component type S : 简易组合型 Simple unit type U : 组合型 组合型 (输入轴) 组合型 (中空轴) Unit type Input shaft unit Hollow unit	35 42 50 63 80	50 80 100 120 160	CR SR SRH SRJ	输入轴径等 Input shaft diameter, etc.

● 段位表 Availability

Ratio matrix

	减速比	50	80	100	120	160
Frame size	尺寸					
	35					
	42					
	50					
	63					
80						

※代码详情请参照尺寸表。

For the code details, please check the Dimensions Table.

减速机规格 Reducer Specifications

尺寸 Size	减速比 Ratio R ^{*1}	容许平均 力矩	容许最大 力矩	紧急最大 力矩	容许平均 输入转速	容许最高 输入转速	寿命时间
		Nominal output torque [Nm]	Maximum output torque [Nm]	Emergency stop torque [Nm]	Nominal input speed [r/min]	Maximum input speed [r/min]	Life [hours]
35	50	7	23	46	3000	8500	10000
	80	10	30	61			
	100	10	36	70			
42	50	21	44	91	3000	7300	
	80	29	56	113			
	100	31	70	143			
50	120	31	70	112	3000	6500	
	50	33	73	127			
	80	44	96	165			
	100	52	107	191			
	120	52	113	191			
63	160	52	120	191	3000	5600	
	50	51	127	242			
	80	82	178	332			
	100	87	204	369			
	120	87	217	395			
80	160	87	229	408	3000	4800	
	50	99	281	497			
	80	153	395	738			
	100	178	433	841			
	120	178	459	892			
	160	178	484	892			

※1 请将R值代入P4所述公式内，求得减速比

※2 输入转速为2000r/min 时的容许最大值

※3 启动、停止时的容许最大值

※4 发生撞击时的容许最大值

※5 运转过程中，平均输入转速的容许最大值

※6 运转过程中，输入转速的容许最大值

※7 输入转速2000r/min，容许额定力矩负荷时的寿命时间

*1 Reduction ratio is to be calculated by the formula in the previous page, using R value in this table.

*2 The maximum allowable value at the input rotation speed of 2000r/min

*3 The maximum torque when starting and stopping.

*4 The maximum torque when it receives shock.

*5 The maximum average input speed.

*6 The maximum input speed.

*7 The life time at the input rotation speed of 2000 r/min and nominal output torque.

尺寸表 *Dimensions Table*

封闭型 部件型
Closed Type, Component

WPC-□ - □ -CR

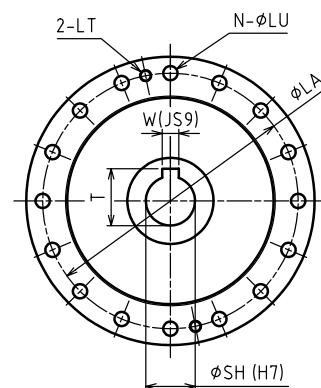
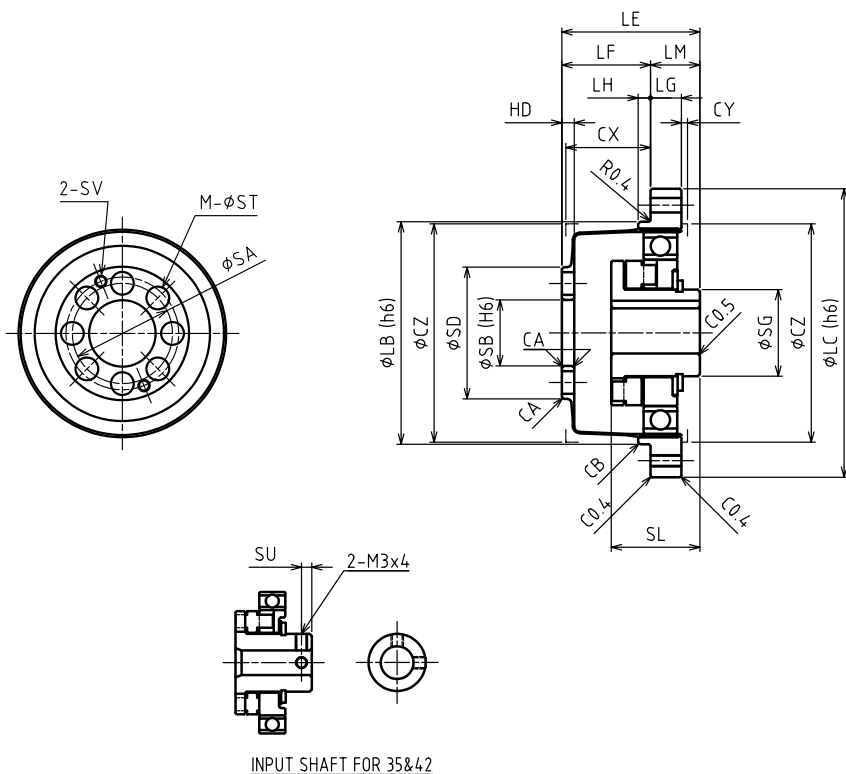

尺寸 Size	重量 Weight	惯性力矩 Moment of inertia
	kg	$\times 10^{-4} \text{kgm}^2$
35	0.10	0.0362
42	0.17	0.0831
50	0.26	0.190
63	0.43	0.414
80	0.91	1.54

[mm]

尺寸 Size	LA	LB	LC	N	LU	LT	LE	LF	LG	LH	LM	SG	SH	SL	W
35	44	38	50	8	3.5	M3	28.5	17.5	6	2	11	14	6	18.5	-
42	54	48	60	16	3.5	M3	32.5	20	6.5	2.5	12.5	18	8	20.7	-
50	62	54	70	16	3.5	M3	33.5	21.5	7.5	3	12	21	12	21.5	4
63	75	67	85	16	4.5	M4	37	24	10	3	13	26	14	21.6	5
80	100	90	110	16	5.5	M5	44	28	14	3	16	26	14	23.6	5

尺寸 Size	T	SU	SA	SB	SD	M	ST	SV	HD	CA	CB	CX	CY	CZ
35	-	2.5	17	11	23	6	4.5	M3	2.4	C0.5	C0.3	17	1	38
42	-	3	19	10	27.2	6	5.5	M3	3	C0.5	C0.4	19	1	45
50	13.8	-	24	16	32	8	5.5	M3	3	C0.5	C0.4	20.5	1.5	53
63	16.3	-	30	20	40	8	6.5	M4	3	C0.5	C0.4	23	1.5	66
80	16.3	-	40	26	52	8	8.8	M5	3.2	C0.5	C0.4	26.8	1.5	86

※1 关于输入部位详情, 请参照单独尺寸图。
※2 CX、CY、CZ为护罩内壁建议尺寸。

*1 For details in the input section, please check the drawings.
*2 Inner dimensions of CX, CY, CZ are recommended dimensions.

规格
Reducer Model /
Specifications

尺寸表
Dimensions Table

寿命计算
(薄壁轴承)
Life estimation
(Elastic bearing)

寿命计算
(主轴承)
Life estimation
(Main bearing)

输入轴容许
负荷
Maximum load at
input shaft

润滑剂
Lubricant information

安装精度
Attachment fixture
requirement

传力力矩
Transmitting Torque

输入部位构造
input
section structure

注意事项
Installation and
assembly
instructions

电机安装方法
Motor installation
procedure

特性数据
Characteristics Data

尺寸表 *Dimensions Table*

封闭型 组合型
Closed Type, Unit

WPU-□ - □ -CR

尺寸 Size	重量 Weight	惯性力矩 Moment of inertia
	kg	×10 ⁻⁴ kgm ²
35	0.50	0.0362
42	0.68	0.0831
50	0.95	0.190
63	1.5	0.414
80	3.3	1.54

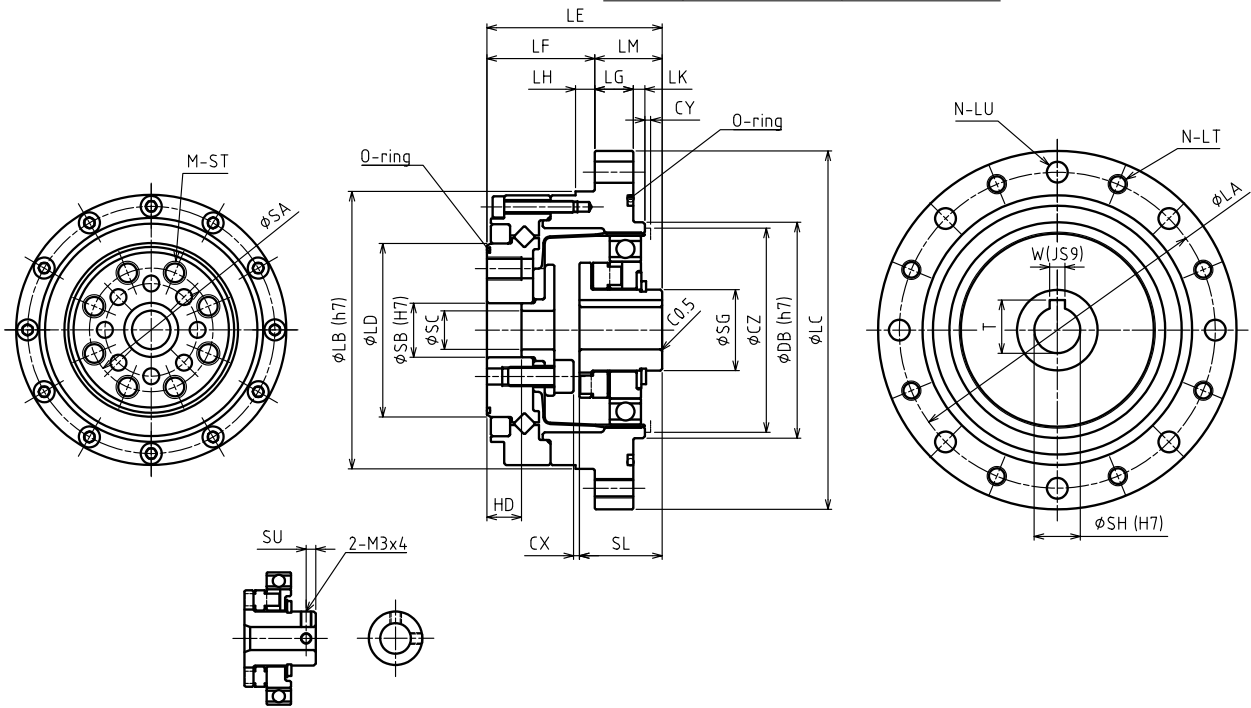

INPUT SHAFT FOR 35&42

[mm]

尺寸 Size	LA	LB	LC	LD	N	LT	LU	LE	LF	LG	LH	LK	LM	DB	SG
35	65	56	73	31	8	M4	4.5	41	27	7	3.5	2	14	38	14
42	71	63	79	38	8	M4	4.5	45	29	8	4	2	16	48	18
50	82	72	93	45	8	M5	5.5	45.5	28	10	5	3	17.5	56	21
63	96	86	107	58	10	M5	5.5	52	36	10	5	3	16	67	26
80	125	113	138	78	12	M6	6.5	62	45	12	5	3	17	90	26

尺寸 Size	SH	SL	W	T	SU	SA	SB	SC	M	ST	HD	CX	CY	CZ
35	6	18.5	-	-	2.5	23	11	8	6	M4 × 8	9.5	1.6	1	38
42	8	20.7	-	-	3	27	10	7	6	M5 × 8	9.5	1.3	1	45
50	12	21.5	4	13.8	-	32	14	10	8	M6 × 9	9	1.5	1.5	53
63	14	21.6	5	16.3	-	42	20	15	8	M8 × 10	12	3.4	1.5	66
80	14	23.6	5	16.3	-	55	26	20	8	M10 × 12	15	5.2	1.5	86

※1 关于输入部位详情，请参照单独尺寸图。
※2 CY、CZ为护罩内壁建议尺寸。

*1 For details in the input section, please check the drawings.
*2 Inner dimensions of CY, CZ are recommended dimensions.

开放型 简易组合型
Open type, Simple unit

WPS-□ - □ -SR

尺寸 Size	重量 Weight	惯性力矩 Moment of inertia
	kg	×10 ⁻⁴ kgm ²
35	0.39	0.0362
42	0.55	0.0831
50	0.79	0.190
63	1.3	0.414
80	2.7	1.54

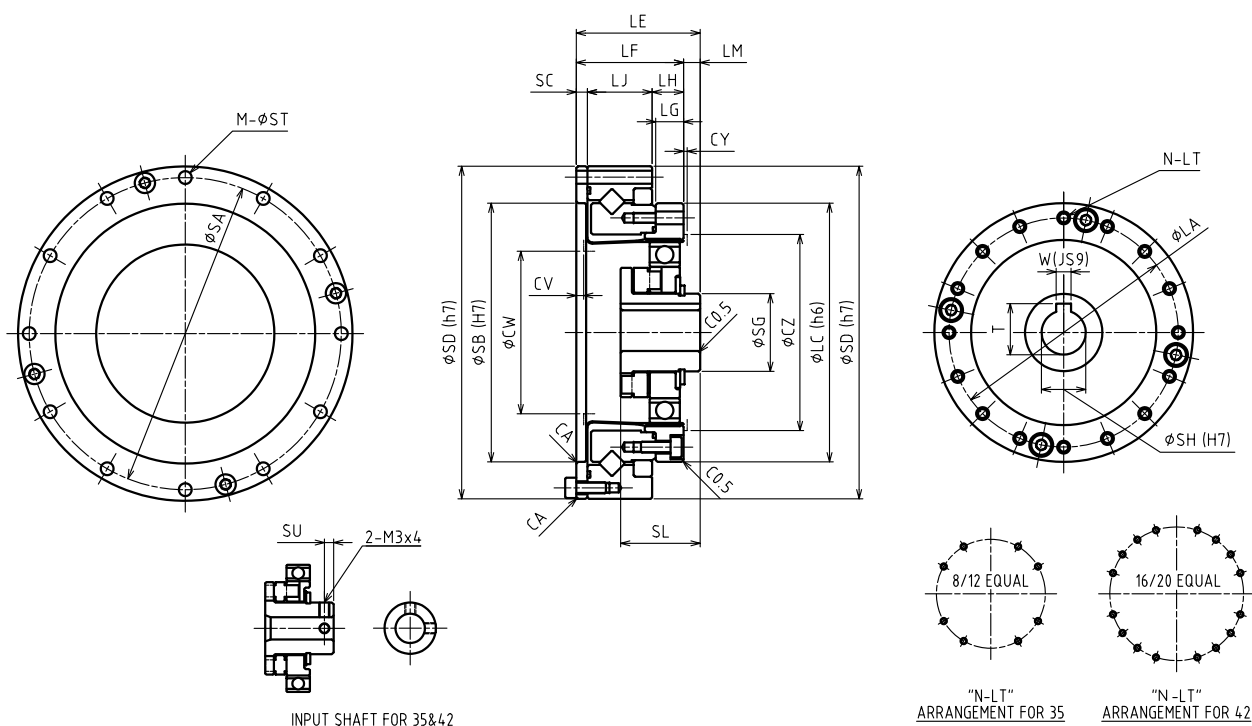

[mm]

尺寸 Size	LA	LC	LE	LF	LG	LH	LJ	LM	SG	SH	SL	W	T	SU	SA	SB
35	44	50	28.5	23.5	6	7	14.1	5	14	6	18.5	-	-	2.5	64	48
42	54	60	32.5	26.5	6.5	7.5	16	6	18	8	20.7	-	-	3	74	60
50	62	70	33.5	29	7.5	8.5	17.5	4.5	21	12	21.5	4	13.8	-	84	70
63	77	85	37	34	10	12	18.7	3	26	14	21.6	5	16.3	-	102	88
80	100	110	44	42	14	15	23.4	2	26	14	23.6	5	16.3	-	132	114

尺寸 Size	SC	SD	M	ST	CA	CY	CZ	CV	CW	N	LT
35	2.4	70	8	3.5	C0.4	1	38	1.6	31	8	M3 × 5, ϕ 3.5 × 6
42	3	80	12	3.5	C0.4	1	45	2	38	16	M3 × 6, ϕ 3.5 × 6.5
50	3	90	12	3.5	C0.4	1.5	53	2	45	16	M3 × 6, ϕ 3.5 × 7.5
63	3.3	110	12	4.5	C0.4	1.5	66	2	56	16	M4 × 7, ϕ 4.5 × 10
80	3.6	142	12	5.5	C0.4	1.5	86	2	73	16	M5 × 8, ϕ 5.5 × 14

※1 关于输入部位详情, 请参照单独尺寸图。
※2 CV、CW、CY、CZ为护罩内壁建议尺寸。

*1 For details in the input section, please check the drawings.
*2 Inner dimensions of CV, CW, CY, CZ are recommended dimensions.

规格
Reducer Model /
Specifications

尺寸表
Dimensions Table

寿命计算
(薄壁轴承)
Life estimation
(Elastic bearing)

寿命计算
(主轴承)
Life estimation
(Main bearing)

输入轴容许
负荷
Maximum load at
input shaft

润滑剂
Lubricant information

安装精度
Attachment fixture
requirement

传动力矩
Transmitting Torque

输入部位构造
Input section structure

注意事项
Installation and
assembly
instructions

电机安装方法
Motor installation
procedure

特性数据
Characteristics Data

尺寸表 *Dimensions Table*

开放型 组合型 (中空轴)
Open type, Unit (hollow shaft)

WPU-□ - □ -SRH

尺寸 Size	重量 Weight	惯性力矩 Moment of inertia
	kg	$\times 10^{-4} \text{kgm}^2$
35	0.72	0.0924
42	1.0	0.207
50	1.4	0.408
63	2.1	1.06
80	4.2	2.72

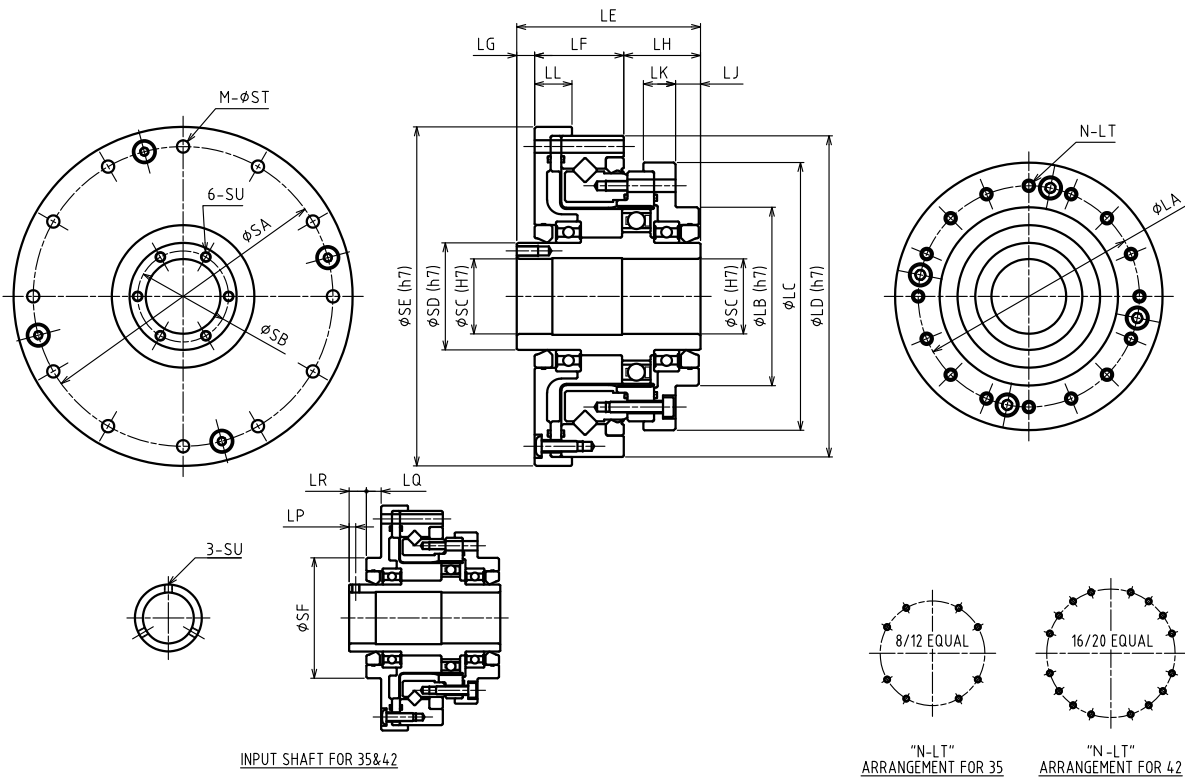

INPUT SHAFT FOR 35&42

"N-LT" ARRANGEMENT FOR 35

"N-LT" ARRANGEMENT FOR 42

[mm]

尺寸 Size	LA	LB	LC	LD	LE	LF	LG	LH	LJ	LK	LL	LP	LQ	LR
35	44	36	54	70	52.5	20.5	12	20	7.5	8	9	2.5	5.5	6.5
42	54	45	64	80	56.5	23	12	21.5	8.5	8.5	10	2.5	5.5	6.5
50	62	50	75	90	51.5	25	5	21.5	7	9	10.5	-	-	-
63	77	60	90	110	55.5	26	6	23.5	6	8.5	10.5	-	-	-
80	100	85	115	142	65.5	32	7	26.5	5	9.5	12	-	-	-

尺寸 Size	SA	SB	SC	SD	SE	SF	M	ST	SU	N	LT
35	64	-	14	20	74	36	8	3.5	M3	8	M3 × 5, φ 3.5 × 11.5
42	74	-	19	25	84	45	12	3.5	M3	16	M3 × 6, φ 3.5 × 12
50	84	25.5	21	30	95	-	12	3.5	M3 × 6	16	M3 × 6, φ 3.5 × 13.5
63	102	33.5	29	38	115	-	12	4.5	M3 × 6	16	M4 × 7, φ 4.5 × 15.5
80	132	40.5	36	45	147	-	12	5.5	M3 × 6	16	M5 × 8, φ 5.5 × 20.5

开放型 组合型 (输入轴)
Open type, Unit (input shaft)

WPU- □ - □ -SRJ

尺寸 Size	重量 Weight	惯性力矩 Moment of inertia
	kg	$\times 10^{-4} \text{kgm}^2$
35	0.65	0.0266
42	0.91	0.0666
50	1.4	0.155
63	2.1	0.382
80	4.1	1.28

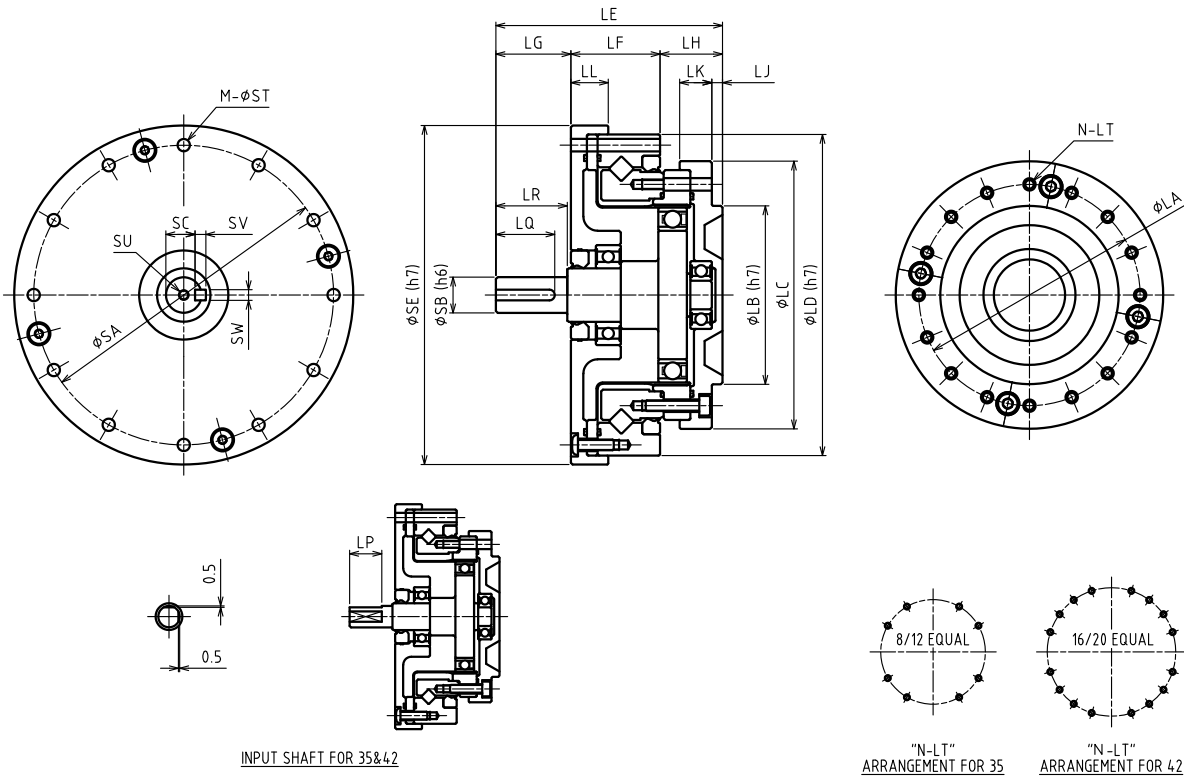

INPUT SHAFT FOR 35&42

"N-LT" ARRANGEMENT FOR 35

"N-LT" ARRANGEMENT FOR 42

[mm]

尺寸 Size	LA	LB	LC	LD	LE	LF	LG	LH	LJ	LK	LL	LP	LQ	LR
35	44	36	54	70	50.5	20.5	15	15	2.5	8	9	11	-	-
42	54	45	64	80	56	23	17	16	3	8.5	10	12	-	-
50	62	50	75	90	63.5	25	21	17.5	3	9	10.5	-	16.5	20
63	77	60	90	110	72.5	26	26	20.5	3	8.5	10.5	-	22.5	25
80	100	85	115	142	84.5	32	26	26.5	5	9.5	12	-	22.5	25

尺寸 Size	SA	SB	SC	SE	SV	SW	M	ST	SU	N	LT
35	64	6	-	74	-	-	8	3.5	-	8	M3 × 5, φ 3.5 × 11.5
42	74	8	-	84	-	-	12	3.5	-	16	M3 × 6, φ 3.5 × 12
50	84	10	8.2	95	3	3	12	3.5	M3 × 6	16	M3 × 6, φ 3.5 × 13.5
63	102	14	11	115	5	5	12	4.5	M5 × 6	16	M4 × 7, φ 4.5 × 15.5
80	132	14	11	147	5	5	12	5.5	M5 × 6	16	M5 × 8, φ 5.5 × 20.5

规格
Reducer Model / Specifications

尺寸表
Dimensions Table

寿命计算
(薄壁轴承)
Life estimation (Elastic bearing)

寿命计算
(主轴承)
Life estimation (Main bearing)

输入轴容许
负荷
Maximum load at input shaft

润滑剂
Lubricant information

安装精度
Attachment fixture requirement

传力力矩
Transmitting Torque

输入部位构造
Input section structure

注意事项
Installation and assembly instructions

电机安装方法
Motor installation procedure

特性数据
Characteristics Data

寿命计算（薄壁轴承） *Life estimation (Elastic bearing)*

薄壁轴承寿命计算

Life span for the elastic bearing

运转类型

Operation cycle example

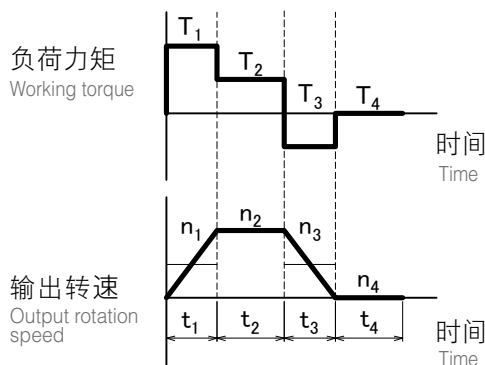

①平均输出力矩 / 最大输出力矩的计算

Calculation formula for output torque

平均输出力矩 Average output torque	Tao	Nm	$Tao = \sqrt[3]{\frac{n_1 \cdot t_1 \cdot T_1 ^3 + n_2 \cdot t_2 \cdot T_2 ^3 + \dots + n_n \cdot t_n \cdot T_n ^3}{n_1 \cdot t_1 + n_2 \cdot t_2 + \dots + n_n \cdot t_n}}$
最大输出力矩 Peak output torque value	Tmo	Nm	Tmo = T ₁ , T ₂ , ... T _n 的最大值 Tmo = Largest among T ₁ , T ₂ , ... T _n

请确认最大输出力矩为容许最大输出值以下

Please make sure the peak output torque is below the maximum output torque in the specification table

②平均输入转速 / 最高输入转速的计算

Calculation formula for input speed

平均输出转速 Average output rotation speed	nao	r/min	$nao = \frac{n_1 \cdot t_1 + n_2 \cdot t_2 + \dots + n_n \cdot t_n}{t_1 + t_2 + \dots + t_n}$
最高输出转速 Peak output rotation speed	nmo	r/min	nmo = n ₁ , n ₂ , ... n _n 的最大值 nmo = Largest among n ₁ , n ₂ , ... n _n
平均输入转速 Average input speed	nai	r/min	$nai = nao \times R$ (R = 减速比) (R = ratio)
最高输入转速 Peak input speed value	nmi	r/min	$nmi = nmo \times R$ (R = 减速比) (R = ratio)

请确认最高输入转速为容许最高输入转速值以下

Please make sure the peak input speed value is below the maximum input speed in the specification table

③寿命时间的计算

Calculation formula for life span

薄壁轴承寿命时间 Part life span for the elastic bearing	Lhe	h	$Lhe = 10000 \times \left(\frac{Tar}{Tao}\right)^3 \times \left(\frac{nar}{nai}\right)$
额定力矩 Rating torque	Tar	Nm	性能表中所记容许平均力矩 Nominal output torque in the specification table
额定输入转速 Rating input rotation speed	nar	r/min	2000 r/min

寿命计算 (主轴承) *Life estimation(Main bearing)*

主轴承规格 (交叉滚子轴承) Main bearing specification(Cross roller bearing)

系列 Series	尺寸 Size	滚轴节圆直径 Pitch circle diameter of the bearing rollers	偏移量 Offset	基本动态额定负荷 Basic dynamic load rating	基本静态额定负荷 Basic static load rating	容许力矩 Allowable moment	力矩刚性 Moment rigidity
		Dm	L	C	Co	Mal	Km
		m	m	N	N	Nm	$\times 10^4 \text{Nm/rad}$
WPU-□-□-CR	35	0.0335	0.0088	5620	6540	36.5	4.38
	42	0.0410	0.0098	6340	8170	55.8	7.75
	50	0.0485	0.0098	10400	13300	91.0	12.8
	63	0.0620	0.0108	15800	21100	156	24.2
	80	0.0815	0.0128	24400	35600	313	53.9
WPS-□-□-SR	35	0.0505	0.0162	7110	10200	74.0	8.5
	42	0.0598	0.0180	10900	15200	124	15.4
	50	0.0708	0.0194	17200	24700	187	25.2
	63	0.0856	0.0234	25100	37400	258	39.2
	80	0.114	0.0292	43300	67600	580	100
WPU-□-□-SRH WPU-□-□-SRJ	35	0.0505	0.0217	7110	10200	74.0	8.5
	42	0.0598	0.0235	10900	15200	124	15.4
	50	0.0708	0.0254	17200	24700	187	25.2
	63	0.0856	0.0289	25100	37400	258	39.2
	80	0.114	0.0357	43300	67600	580	100

主轴承寿命计算

Life span for the main bearing

运转类型

Operation cycle example

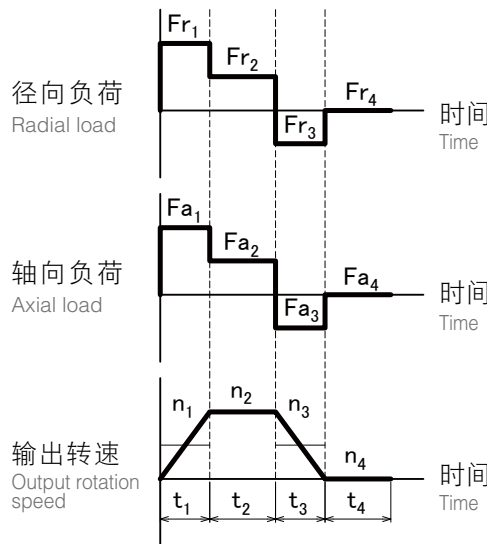

外部负荷

External load

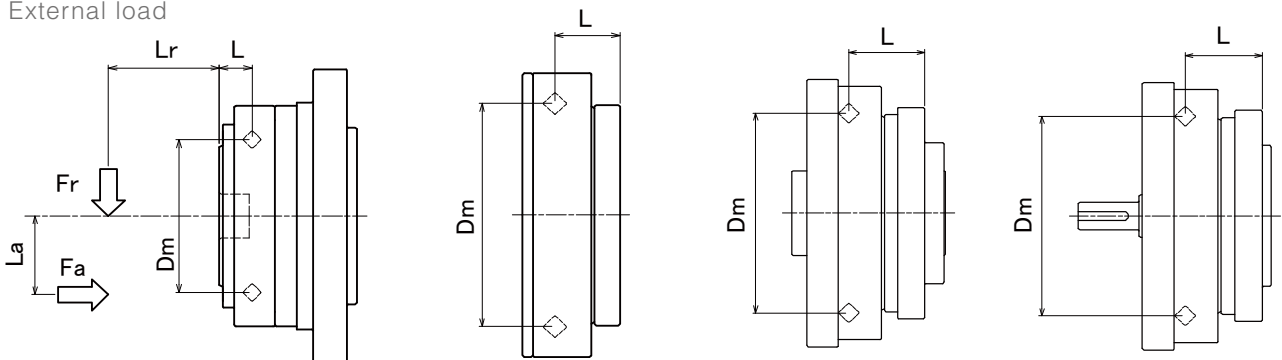

规格 Reducer Model / Specifications	减速机型号 / 规格
尺寸表 Dimensions Table	尺寸表
寿命计算 (弹性轴承) Life estimation (Elastic bearing)	寿命计算 (弹性轴承)
寿命计算 (主轴承) Life estimation (Main bearing)	寿命计算 (主轴承)
输入轴容许 负荷 Maximum load at input shaft	输入轴容许 负荷
润滑剂 Lubricant information	润滑剂
安装精度 Attachment fixture requirement	安装精度
传递力矩 Transmitting Torque	传递力矩
输入部位构造 Input section structure	输入部位构造
注意事项 Installation and assembly instructions	注意事项
电机安装方法 Motor installation procedure	电机安装方法
特性数据 Characteristics Data	特性数据

寿命计算（主轴承） *Life estimation (Main bearing)*

①最大负荷惯量的计算

Calculation formula for the largest working moment

最大负荷惯量 Peak working moment	Mm	Nm	$Mm = Frm \cdot (Lr + L) + Fam \cdot La$
最大径向负荷 Peak radial load	Fr _m	N	Fr _m = Fr ₁ , Fr ₂ ... Fr _n 的最大值 Fr _m = Largest among Fr ₁ , Fr ₂ , ... Fr _n
最大轴向负荷 Peak axial load	Fa _m	N	Fa _m = Fa ₁ , Fa ₂ , ... Fa _n 的最大值 Fa _m = Largest among Fa ₁ , Fa ₂ , ... Fa _n

请确认最大负荷惯量为容许惯量值以下

Please make sure the peak working moment is below the maximum allowable moment

②平均径向负荷/ 轴向负荷/ 平均输出转速/ 平均负荷惯量的计算

Calculation formula for the Average radial load, Axial load, Average output rotation speed, Average working moment

平均径向负荷 Average radial load	Fra	N	$Fra = \frac{10^3}{\sqrt[3]{n_1 \cdot t_1 \cdot Fr_1 ^{10/3} + n_2 \cdot t_2 \cdot Fr_2 ^{10/3} + \dots + n_n \cdot t_n \cdot Fr_n ^{10/3}}}$
平均轴向负荷 Axial load	Faa	N	$Faa = \frac{10^3}{\sqrt[3]{n_1 \cdot t_1 \cdot Fa_1 ^{10/3} + n_2 \cdot t_2 \cdot Fa_2 ^{10/3} + \dots + n_n \cdot t_n \cdot Fa_n ^{10/3}}}$
平均输出转速 Average output rotation speed	nao	r/min	$nao = \frac{n_1 \cdot t_1 + n_2 \cdot t_2 + \dots + n_n \cdot t_n}{t_1 + t_2 + \dots + t_n}$
平均负荷惯量 Average working moment	Ma	Nm	$Ma = Fra \cdot (Lr + L) + Faa \cdot La$

③负荷系数/ 动态等价径向负荷的计算

Calculation formula for the Loading factor, Equivalent radial load

负荷系数 Loading factor	Xc, Yc	-	$\frac{Faa}{Fra + 2Ma / Dm} \leq 1.5$ 时, Xc = 1.0, Yc = 0.45
			$\frac{Faa}{Fra + 2Ma / Dm} > 1.5$ 时, Xc = 0.67, Yc = 0.67
动态等价径向负荷 Equivalent radial load	Pc	N	$Pc = Xc \cdot (Fra + 2Ma/Dm) + Yc \cdot Faa$

④主轴承寿命时间的计算

Life span for the main bearing

主轴承寿命时间 Life span for the main bearing	Lhc	h	$Lhc = \frac{10^6}{60 \cdot nao} \cdot \left(\frac{C}{fw \cdot Pc} \right)^{\frac{10}{3}}$
冲击系数 Impact factor	f w	-	1.0 : 未伴随冲击时 no shock
			1.2 : 伴随些许冲击时 with some shock
			1.5 : 伴随振动冲击时 with shock and vibration

输入轴容许负荷 *Maximum load at input shaft*

■ 轴承规格（开放型，组合型） Bearing specification (Open type, Unit)

系列 Series	尺寸 Size	轴承 A Bearing A		轴承 B Bearing B		a	b
		基本动态额定负荷 Basic dynamic load rating	基本静态额定负荷 Basic static load rating	基本动态额定负荷 Basic dynamic load rating	基本静态额定负荷 Basic static load rating		
		C	Co	C	Co		
		N	N	N	N		
WPU-□-□-<i>SRH</i>	35	4000	2470	4000	2470	16	27
	42	4300	2950	4300	2950	16	31
	50	4500	3450	4500	3450	14.5	27.5
	63	4900	4350	4900	4350	15.5	30.8
	80	14100	10900	5350	5250	19	37.0
WPU-□-□-<i>SRJ</i>	35	2240	910	1080	430	24	21.5
	42	2700	1270	1610	710	27	23.5
	50	4350	2260	2240	910	31.5	26
	63	5600	2830	2700	1270	37.5	29
	80	9400	5000	4350	2260	39	38.5

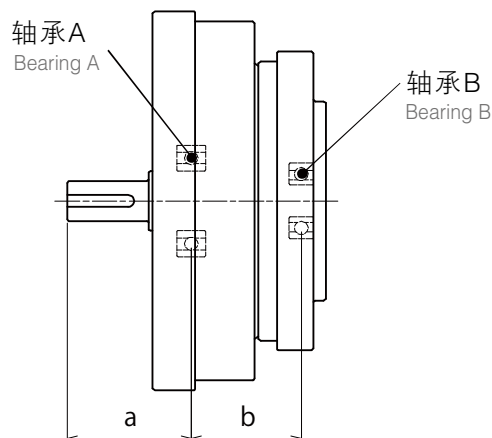
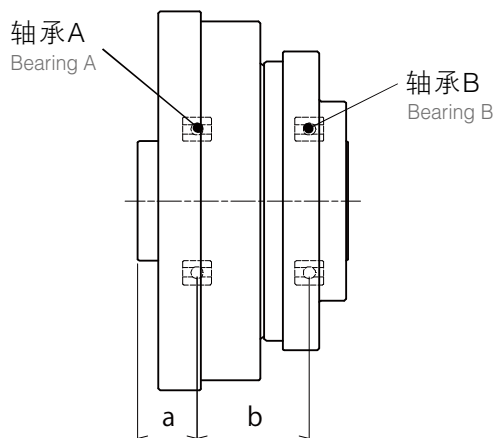

■ 容许负荷（平均输入转速：2000r/min、寿命时间：10000h）

Maximum load (Average input rotation speed : 2000r/min, Life span : 10000h)

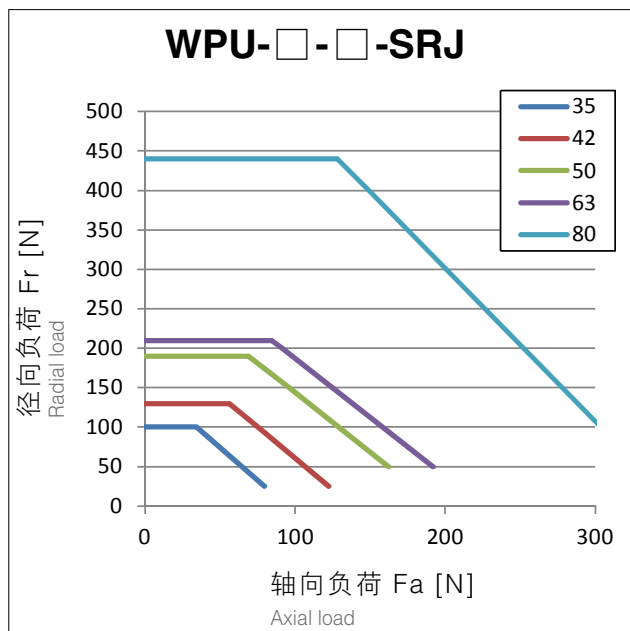
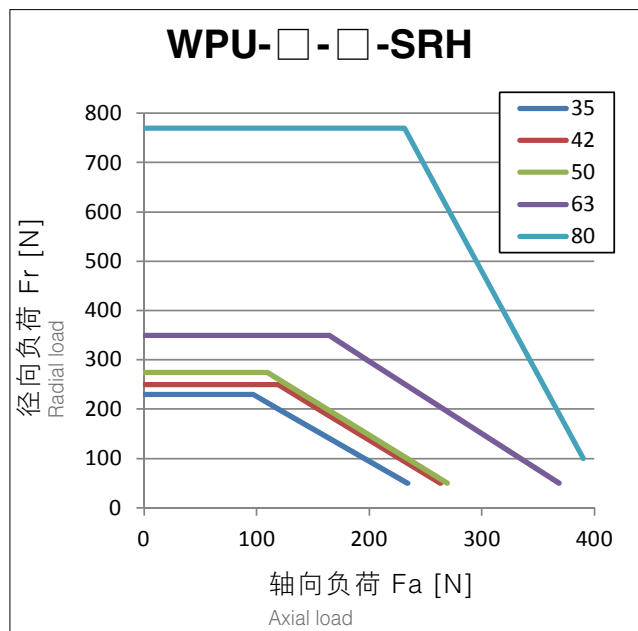

减速机型号 /
规格
Reducer Model /
Specifications

尺寸表
Dimensions Table

寿命计算
(游隙轴承)
Life estimation
(Elastic bearing)

寿命计算
(主轴承)
Life estimation
(Main bearing)

输入轴容许
负荷
Maximum load at
Input shaft

润滑剂
Lubricant information

安装精度
Attachment fixture
requirement

传导力矩
Transmitting Torque

输入部位构造
Input
section structure

注意事项
Installation and
assembly
instructions

电机安装方法
Motor installation
procedure

特性数据
Characteristics Data

润滑剂 *lubricant information*

润滑剂的使用

Grease

Sumiplex SFB No.1 (日本住矿润滑剂株式会社) Sumiplex SFB No.1 (SUMICO LUBRICANT CO., LTD.)

使用温度范围: 0 ~ 40°C (环境温度) Operating temperature range: 0-40°C (ambient temperature)

润滑剂的涂抹

Grease application

按照以下要求在减速机各部位涂抹润滑剂。 Please apply grease according to the table below.

■ 润滑剂涂抹量 Grease application

·根据减速机的安装方向（输出侧为横向、向上、向下）不同，变更涂抹部位C的涂抹量。
（已封入润滑油的组合类型，填充了C（横向）的润滑油量。）

·输入ASSY~护罩内壁空间的50%的润滑剂。

·由于护罩设计造成润滑剂不足时，请咨询本公司。

[g]

·The quantity of grease applied to C should be adjusted depending on the mounting direction.
C of the unit type product is already filled with the same quantity of grease as horizontal mounting.

·50% of the space between input assy and casing inner wall should be filled with grease.

·If the amount of grease is not sufficient due to case design, please contact us.

尺寸 Size	涂抹部位 Applied part					
	A	B	C (横向) Horizontal	C (向上) Vertical up	C (向下) Vertical down	D
35	0.3	0.3	6	8	9	0.3
42	0.5	0.5	10	12	14	0.5
50	0.8	0.8	16	18	21	0.8
63	1.5	1.5	30	35	40	1.5
80	3.0	3.0	60	70	80	3.0

■ 润滑剂涂抹部位 Grease application location

WPC-□-□-CR

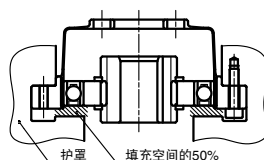
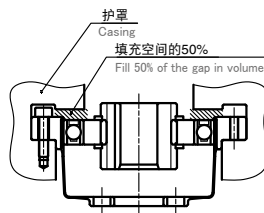
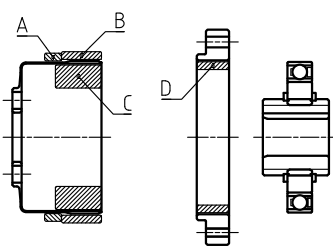

WPU-□-□-CR

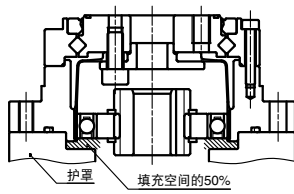
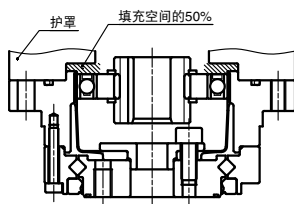
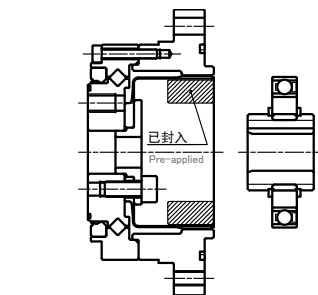

WPS-□-□-SR

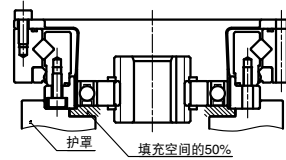
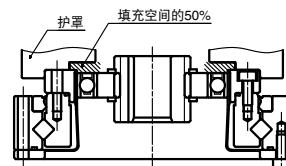
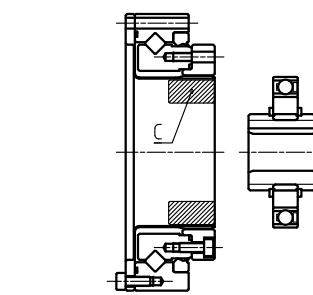

安装精度 Attachment fixture requirement

■ 安装精度 Attachment fixture requirement

WPC-□-□-CR

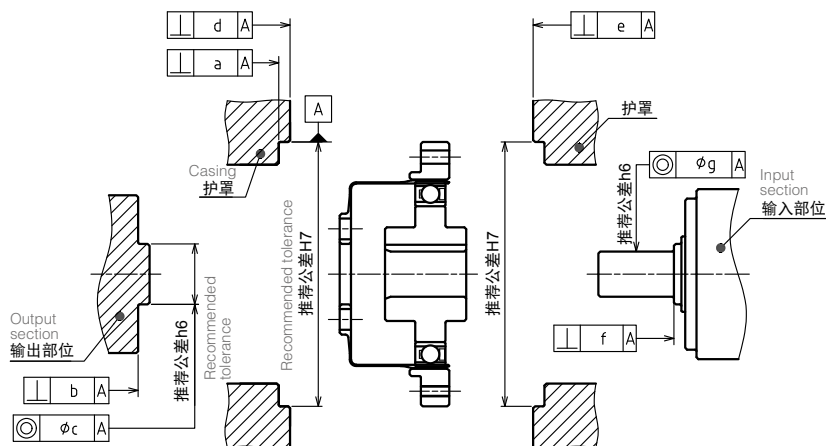

安装精度 [mm]

尺寸 Size	35	42	50	63	80
a	0.015	0.015	0.018	0.018	0.023
b	0.010	0.012	0.014	0.016	0.020
c	0.013	0.013	0.015	0.018	0.020
d	0.015	0.015	0.018	0.018	0.023
e	0.015	0.015	0.018	0.018	0.023
f	0.012	0.012	0.014	0.016	0.016
g	0.016	0.020	0.024	0.024	0.024

WPU-□-□-CR

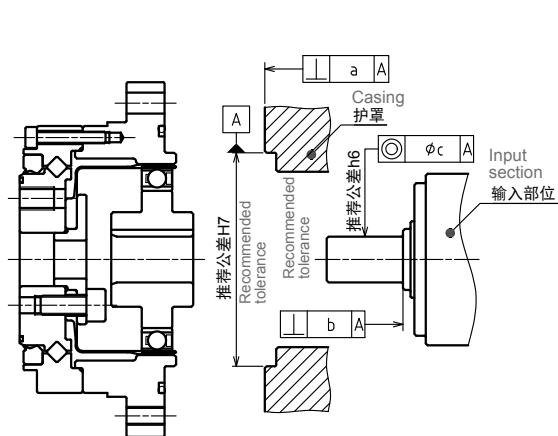

安装精度 [mm]

尺寸 Size	35	42	50	63	80
a	0.020	0.020	0.020	0.025	0.025
b	0.012	0.012	0.014	0.016	0.016
c	0.016	0.020	0.024	0.024	0.024

WPS-□-□-SR

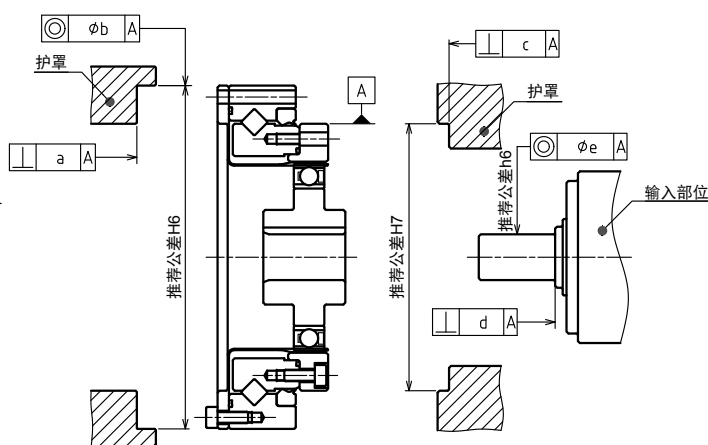

安装精度 [mm]

尺寸 Size	35	42	50	63	80
a	0.025	0.025	0.025	0.030	0.030
b	0.020	0.020	0.020	0.025	0.025
c	0.020	0.020	0.020	0.025	0.025
d	0.012	0.012	0.014	0.016	0.016
e	0.016	0.020	0.024	0.024	0.024

规格
Reducer Model / Specifications

尺寸表
Dimensions Table

寿命计算
(薄壁轴承)
Life estimation
(Elastic bearing)

寿命计算
(主轴承)
Life estimation
(Main bearing)

输入轴容许
负荷
Maximum load at
input shaft

润滑剂
Lubricant
information

安装精度
Attachment
fixture
requirement

传动力矩
Transmitting Torque

输入部位构造
Input section structure

注意事项
Installation and
assembly
instructions

电机安装方法
Motor installation
procedure

特性数据
Characteristics Data

传导力矩 *Transmitting Torque*

安装螺丝

Bolting

螺丝紧固力矩如下表所示。

通过螺丝个数及紧固力矩调整，可传导力矩存在差异，所以请注意确认。

Please refer to the table below for the bolt tightening torque.

Please be noted that the transmittable torque varies depending on the bolt count (different between CF and CN) and tightening torque.

螺丝紧固力矩

Tightening torque for bolts

螺丝尺寸	Bolt size	M3	M4	M5	M6	M8	M10	建议螺丝：强度区分12.9以上
紧固力矩 [Nm]	Tightening torque	1.9	4.3	8.7	15	36	71	Recommended bolt : Strength rating above 12.9

传导力矩 (封闭型、组合型)

Bolt specifications and Transmitting torque (Closed type, Unit)

安装输出法兰 Output flange attachment

尺寸	Size	35	42	50	63	80
螺丝尺寸	Bolt size	M4	M5	M6	M8	M10
螺丝个数	Bolt count	6	6	8	8	8
安装PCD [mm]	Bolt PCD	23	27	32	42	55
紧固力矩 [Nm]	Tightening torque	4.3	8.7	15	36	71
传导力矩 [Nm]	Transmitting torque	56	106	238	566	1177

安装内齿轮 (CR) Internal gear attachment

尺寸	Size	35	42	50	63	80
螺丝尺寸	Bolt size	M4	M4	M5	M5	M6
螺丝个数	Bolt count	8	8	8	10	12
安装PCD [mm]	Bolt PCD	65	71	82	96	125
紧固力矩 [Nm]	Tightening torque	4.3	4.3	8.7	8.7	15
传导力矩 [Nm]	Transmitting torque	210	230	430	629	1392

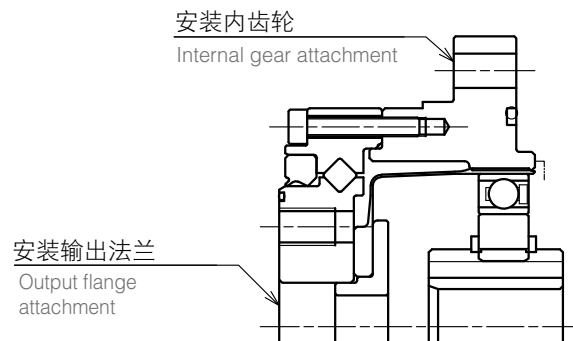

传导力矩 (封闭型、部件型)

Bolt specifications and Transmitting torque (Closed type, Component)

安装柔性齿轮 Flex Gear Attachment

尺寸	Size	35	42	50	63	80
螺丝尺寸	Bolt size	M4	M5	M5	M6	M8
螺丝个数	Bolt count	6	6	8	8	8
安装PCD [mm]	Bolt PCD	17	19	24	30	40
紧固力矩 [Nm]	Tightening torque	4.3	8.7	8.7	15	36
传导力矩 [Nm]	Transmitting torque	41	75	126	223	539

安装内齿轮 (CR) Internal Gear Attachment

尺寸	Size	35	42	50	63	80
螺丝尺寸	Bolt size	M3	M3	M3	M4	M5
螺丝个数	Bolt count	8	16	16	16	16
安装PCD [mm]	Bolt PCD	44	54	62	75	100
紧固力矩 [Nm]	Tightening torque	1.9	1.9	1.9	4.3	8.7
传导力矩 [Nm]	Transmitting torque	82	200	230	485	1048

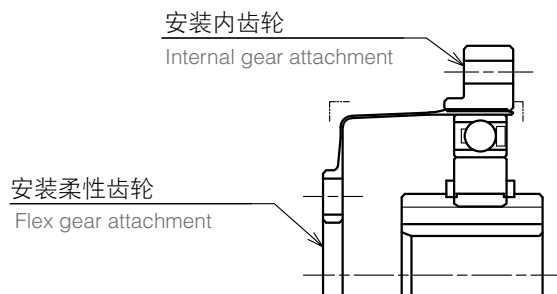

◆销子孔的追加 Reinforcement

柔性齿轮安装的传导力矩未满足要求时，请同时使用销子。
销子孔可根据需求追加。

Pins can be added if the transmittable torque at the flex gear interface is not sufficient.
As an option, holes can be added.

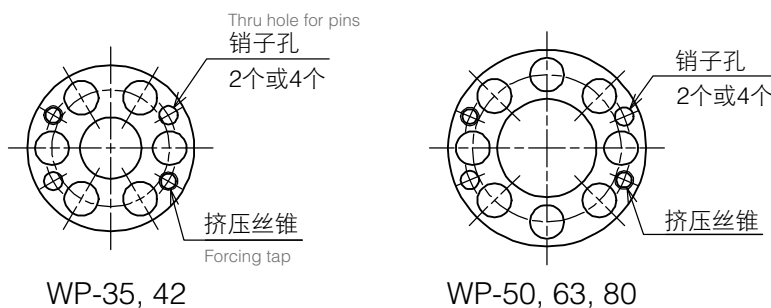

规格
Reducer Model /
Specifications

尺寸表
Dimensions Table

寿命计算
(薄壁轴承)
Life estimation
(Elastic bearing)

寿命计算
(主轴承)
Life estimation
(Main bearing)

输入轴容许
负荷
Maximum load at
input shaft

润滑剂
Lubricant information

安装精度
Attachment fixture
requirement

传导力矩
Transmitting
Torque

输入部位构造
Input
section structure

注意事项
Installation and
assembly
instructions

电机安装方法
Motor installation
procedure

特性数据
Characteristics Data

传导力矩 *Transmitting Torque*

传导力矩 (开放型)

Bolt specifications and Transmitting torque (Open type)

安装柔性齿轮 Flex Gear Attachment

尺寸	Size	35	42	50	63	80
螺丝尺寸	Bolt size	M3	M3	M3	M4	M5
螺丝个数	Bolt count	8	12	12	12	12
安装PCD [mm]	Bolt PCD	64	74	84	102	132
紧固力矩 [Nm]	Tightening torque	1.9	1.9	1.9	4.3	8.7
传导力矩 [Nm]	Transmitting torque	119	206	234	495	1037

安装内齿轮 Internal Gear Attachment

尺寸	Size	35	42	50	63	80
螺丝尺寸	Bolt size	M3	M3	M3	M4	M5
螺丝个数	Bolt count	8	16	16	16	16
安装PCD [mm]	Bolt PCD	44	54	62	77	100
紧固力矩 [Nm]	Tightening torque	1.9	1.9	1.9	4.3	8.7
传导力矩 [Nm]	Transmitting torque	82	200	230	498	1048

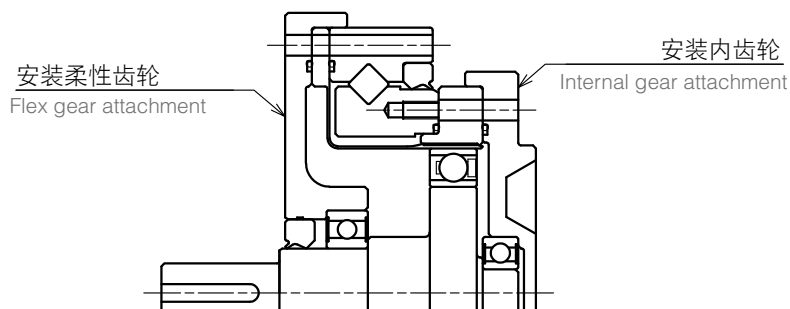
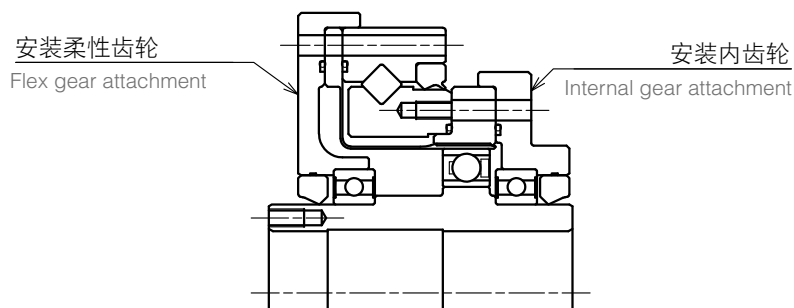
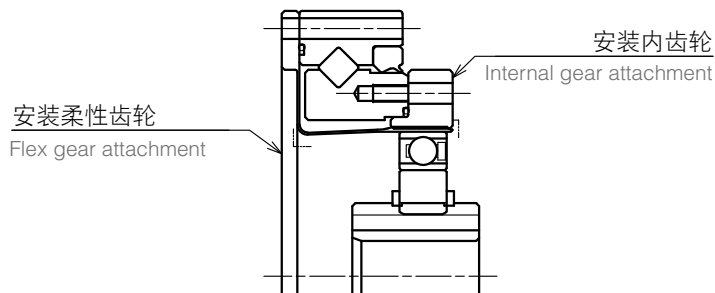

输入部位构造 *Input section structure*

输入部位构造

Input section structure

输入部位构造分为十字滑块型（自动调心构造）与刚构型，因输入孔径等差异而不同。详细信息请确认尺寸图。

There are two types of input section structure, oldham type (self-centering feature) and rigid type.

十字滑块型（自动调心构造）

Oldham type (self-centering)

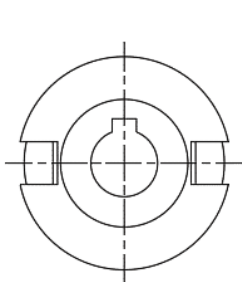

刚构型

Rigid type

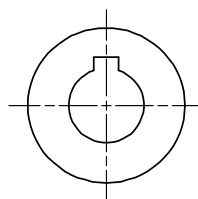
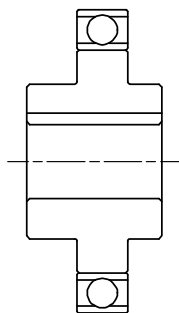
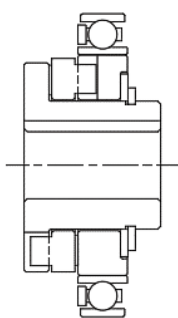

凸轮孔径尺寸

Cam hole diameter

凸轮孔径尺寸可变更。若在下表标准孔径尺寸以下时，则为十字滑块型，在标准孔径～最大孔径范围，则为刚构型。若需下表范围以外尺寸，请另行咨询我公司。

The diameter of the cam opening is customizable. Holes smaller than the 'standard hole size' in the table will be built in the oldham type. Holes equal to or larger than the 'standard hole size' and smaller than the 'maximum hole size' will be built in the rigid type. Please contact us if you need sizes outside the specification in the table.

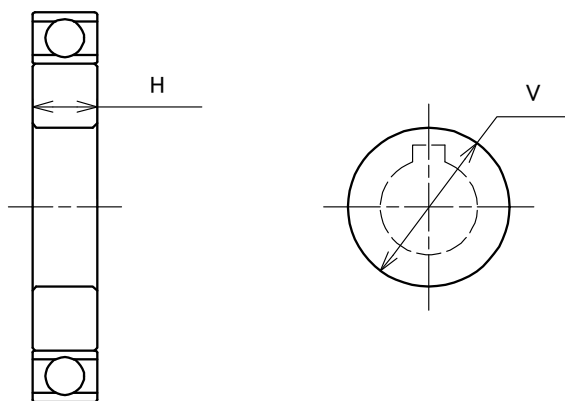

凸轮尺寸 Cam dimension

[mm]

尺寸 Size	35	42	50	63	80
标准孔径 standard bore size	6	8	12	14	14
最大孔径 V maximum bore size	17	20	23	28	36
最小厚度 H minimum thickness	6	7	8	9	11

规格
Reducer Model /
Specifications

尺寸表
Dimensions Table

寿命计算
(薄壁轴承)
Life estimation
(Elastic bearing)

寿命计算
(主轴承)
Life estimation
(Main bearing)

输入轴容许
负荷
Maximum load at
input shaft

润滑剂
Lubricant information

安装精度
Attachment fixture
requirement

传力矩
Transmitting
Torque

输入部位构造
Input section
structure

注意事项
Installation and
assembly
instructions

电机安装方法
Motor installation
procedure

特性数据
Characteristics Data

注意事项 *Installation and assembly instructions*

输入/输出轴的支撑 (WPC-□-□-CR)

Shaft installation instruction

输入轴 / 输出轴请采用承受作用于轴部的径向负荷 / 轴向负荷的支撑构造。(下图为参考实例)
来自减速机内部的轴向负荷作用于凸轮。请进行固定，避免凸轮发生轴向移动。

Please design the support structure for input shaft and output shaft so that both radial and axial loads are supported. (Diagram below shows an example)

Inside thrust load has effect on the cam. Secure cam from the possible axial movement.

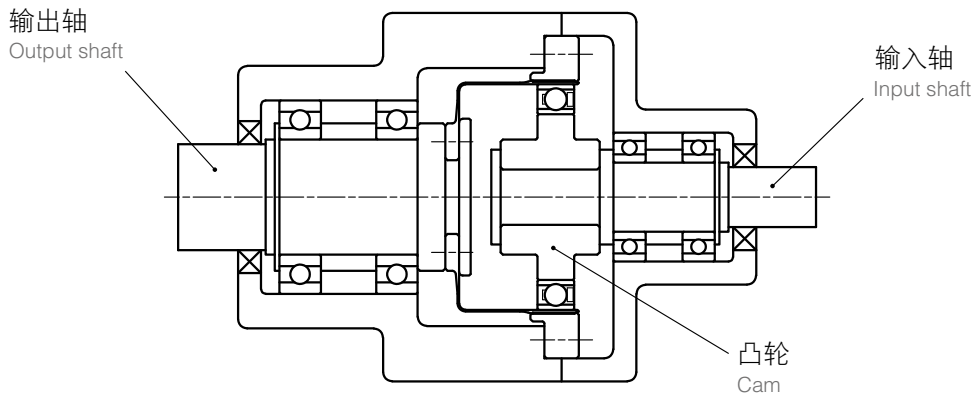

安装方法 (WPC-□-□-CR)

Attachment flange requirement

安装与柔性齿轮相连接的法兰时，为了防止造成柔性齿轮破损，请保证下表所示尺寸。

For the attachment flange that comes in contact with flex gear, please build the corner radius according to the table below, in order to prevent damage.

	[mm]				
符号 Item	35	42	50	63	80
D	24.5	29	34	42	55
R	1.2	1.2	1.4	1.5	2
t	2	2.5	2.5	5	7

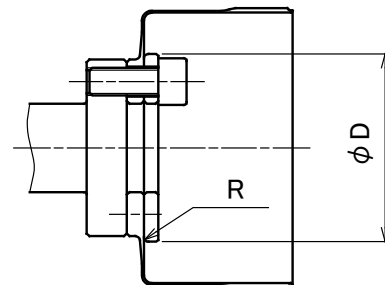

电机安装方法 *Motor installation procedure*

电机安装方法(WPU-□-□-□)

Motor installation procedure

■ 安装步骤1

- 将法兰安装至电机上
- 将凸轮（轴承）安装至电机轴上
- 安装至组合型产品组件

Procedure 1

- Attach the flange on to the motor
- Attach the cam with elastic bearings to the motor shaft
- Attach the unit

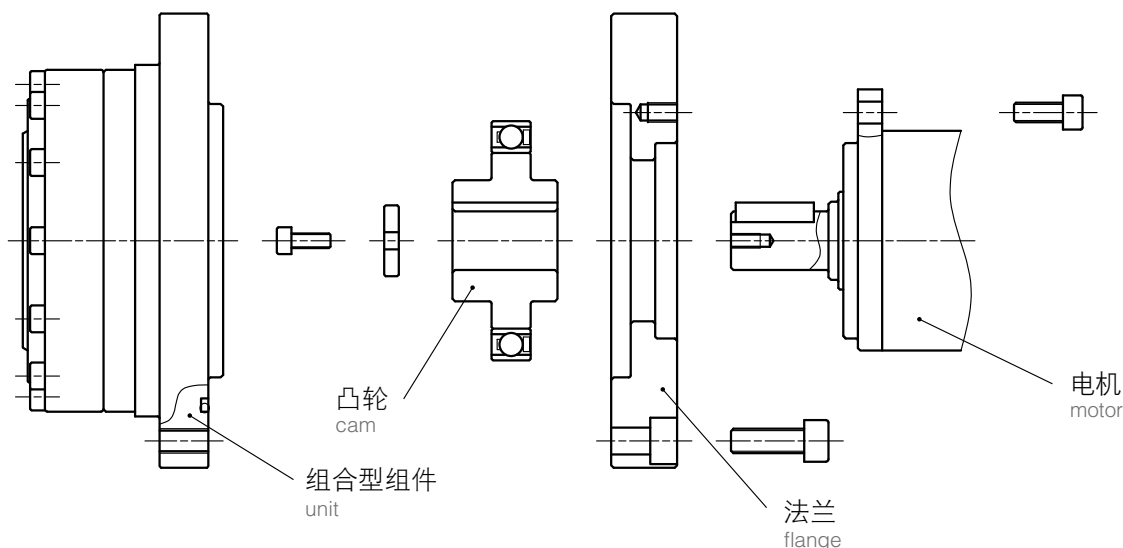

■ 安装步骤2

- 将凸轮（轴承）安装至电机轴上
- 将法兰安装至电机上
- 安装至组合型产品组件

Procedure 2

- Attach the cam with elastic bearings to the motor shaft
- Attach the flange on to the motor
- Attach the unit

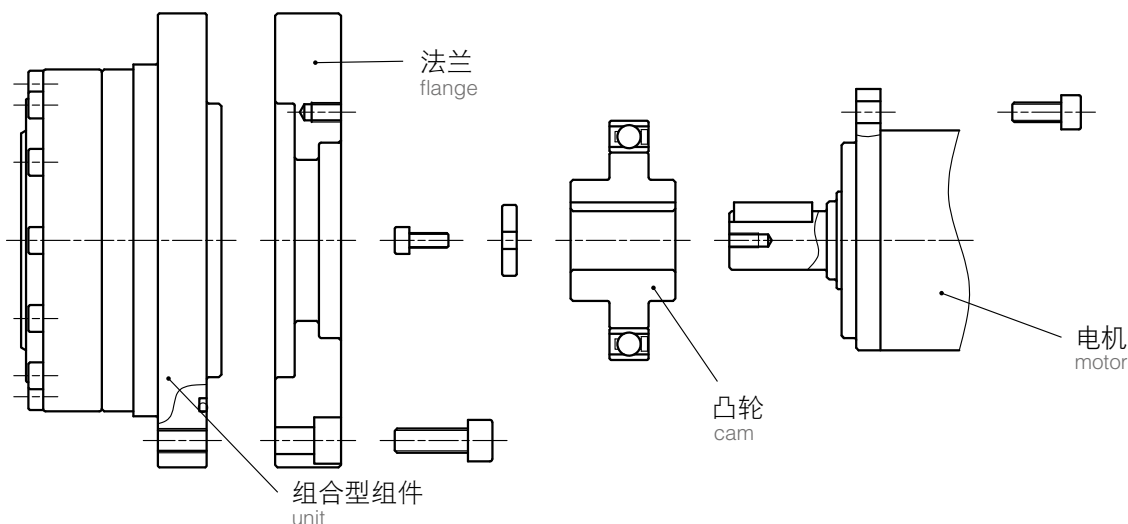

安装操作时的注意事项 *Caution during installation*

- 组装各零部件时，不可过度用力顶压。
- 注意不可倾斜插入输入 ASSY（凸轮、电机）。
- Do not use excessive force while mating parts
- Please watch for tilting during input section assembly (motor insertion into cam)

规格 Reducer Model / Specifications	减速机型号 / 规格	尺寸表 Dimensions Table	寿命计算 (薄壁轴承) Life estimation (Elastic bearing)	寿命计算 (主轴承) Life estimation (Main bearing)	输入轴容许 负荷 Maximum load at input shaft	润滑剂 Lubricant information	安装精度 Attachment fixture requirement	传导力矩 Transmitting Torque	输入部位构造 Input section structure	注意事项 Installation and assembly instructions	电机安装方法 Motor installation procedure	特性数据 Characteristics Data
---	---------------	-------------------------	--	--	---	------------------------------	---	-----------------------------	-----------------------------------	--	---	------------------------------

特性数据 Characteristics Data

棘轮扭矩 (Closed type)

Ratcheting torque

减速比 Ratio	尺寸 Size				
	35	42	50	63	80
50	120	220	340	650	1400
80	140	250	410	700	1600
100	130	210	340	690	1300
120	-	200	310	680	1200
160	-	-	300	620	1000

屈曲扭矩 (Closed type)

Buckling torque

减速比 Ratio	尺寸 Size				
	35	42	50	63	80
50 ~ 160	260	500	800	1700	3500

棘轮扭矩 (Open type)

Ratcheting torque

减速比 Ratio	尺寸 Size				
	35	42	50	63	80
50	120	220	340	650	1400
80	140	250	410	700	1600
100	130	210	340	690	1300
120	-	200	310	680	1200
160	-	-	300	620	1000

屈曲扭矩 (Open type)

Buckling torque

减速比 Ratio	尺寸 Size				
	35	42	50	63	80
50 ~ 160	180	350	590	1100	2400

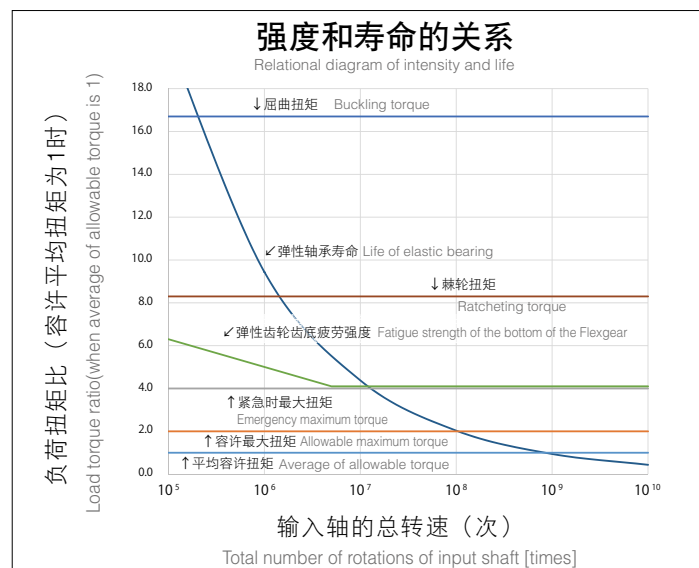

※ 上图以实际测量数据为基础制作。请作为参考值参考。

* The graph is based on actual measurement value. For reference only.

角度传导精度

Transmission Angular Accuracy

角度传导精度定义

在无负荷条件下使输入轴旋转时，理论上输出旋转角度与实际输出旋转角度的差值。

What is Transmission Angular Accuracy?

It is the difference between the measured output rotation angle and the theoretical angle, while input shaft is rotated with no load.

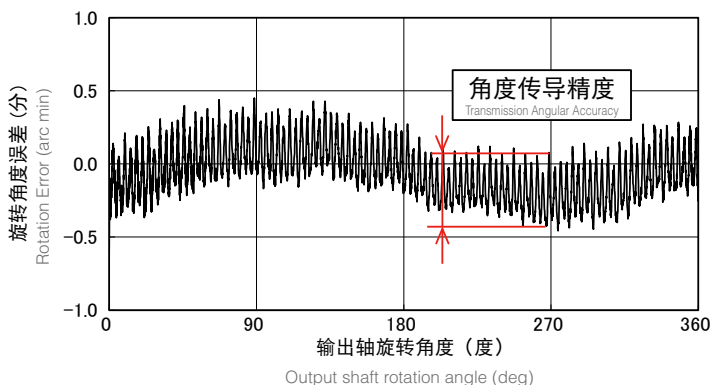

[arc min]

减速比 Ratio	尺寸 Size				
	35	42	50	63	80
50	2.0	2.0	1.5	1.0	1.0
80	1.5	1.5	1.0	1.0	1.0
100	1.5	1.5	1.0	1.0	1.0
120	-	1.5	1.0	1.0	1.0
160	-	-	1.0	1.0	1.0

※表中数值为参考值。

Table values are reference values.

滞后损失

Hysteresis Loss

滞后损失定义

输入侧固定后，将力矩施加至输出侧且0力矩时的扭曲角度差。

What is Hysteresis Loss?

When torque load is applied at the output shaft in alternate direction repeatedly with input shaft fixed, there is residual twisting angle when torque is back to zero.

In this context, hysteresis loss is the difference in the forward and backward twisting angle.

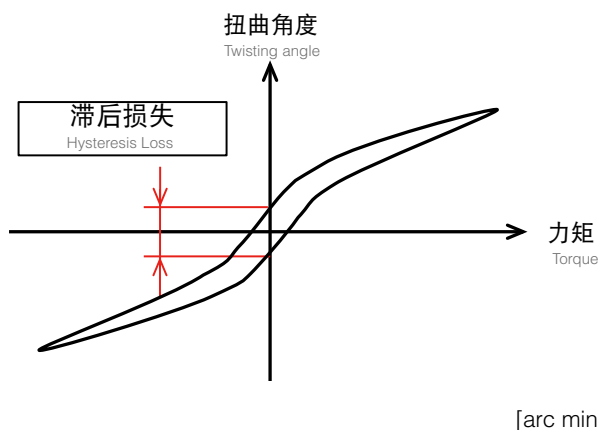

[arc min]

减速比 Ratio	尺寸 Size				
	35	42	50	63	80
50	2.0	2.0	2.0	2.0	2.0
80	1.5	1.5	1.0	1.0	1.0
100	1.5	1.5	1.0	1.0	1.0
120	-	1.5	1.0	1.0	1.0
160	-	-	1.0	1.0	1.0

规格
Reducer Model / Specifications

尺寸表
Dimensions Table

寿命计算
(薄壁轴承)
Life estimation (Elastic bearing)

寿命计算
(主轴承)
Life estimation (Main bearing)

输入轴容许
输入负荷
Maximum load at input shaft

润滑剂
Lubricant information

安装精度
Attachment fixture requirement

传动力矩
Transmitting Torque

输入部位构造
Input section structure

注意事项
Installation and assembly instructions

电机安装方法
Motor installation procedure

特性数据
Characteristics Data

特性数据 Characteristics Data

最大背隙

Maximum Backlash

[arc sec]

最大背隙定义

输入部采用十字滑块型组件时的输出侧松动间隙
(齿轮相咬合部位背隙为0, 所以刚构型组件背隙为0)

What is Maximum Backlash?

In this context, maximum backlash is the output backlash for oldham type input shaft. (Backlash is zero for rigid type input, because gear engagement backlash is zero.)

减速比 Ratio	尺寸 Size				
	35	42	50	63	80
50	42	35	30	24	19
80	27	22	19	15	12
100	21	18	15	12	9
120	-	15	13	10	8
160	-	-	9	7	6

刚性 (封闭型、组合型)

Stiffness (Closed type, Unit)

刚性定义

固定输入侧, 将力矩施加至输出侧时的弹簧常数与
扭曲角度

What is Stiffness?

In this context, stiffness is the output shaft twisting angle and the spring coefficient, while torque load is applied to the output shaft with input side fixed.

- K1...力矩 0 ~ T₁ 的弹簧常数
Spring coefficient at 0 ~ T₁ torque
- K2...力矩 T₁ ~ T₂ 的弹簧常数
Spring coefficient at T₁ ~ T₂ torque
- K3...力矩 T₂ ~ 的弹簧常数
Spring coefficient at T₂ ~ torque

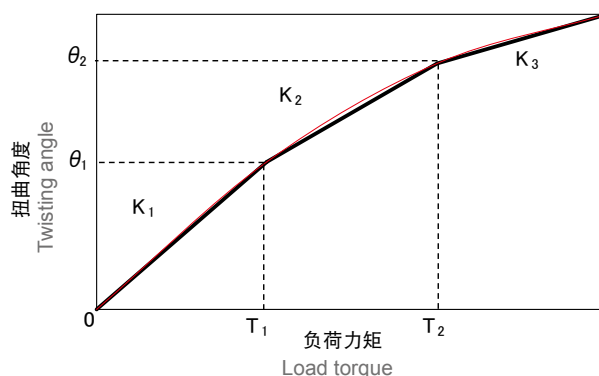

减速比 Ratio	符号 item	单位 unit	尺寸 Size				
			35	42	50	63	80
-	T ₁	Nm	2	3.9	7	14	29
-	T ₂	Nm	6.9	12	25	48	108
50	K ₁	× 10 ⁴ Nm/rad	0.41	0.87	1.3	2.5	5.5
	K ₂	× 10 ⁴ Nm/rad	0.57	1.1	1.8	3.4	7.9
	K ₃	× 10 ⁴ Nm/rad	0.70	1.4	2.4	4.5	10
	θ ₁	arcmin	1.7	1.5	1.9	1.9	1.8
	θ ₂	arcmin	4.6	4.1	5.3	5.4	5.3
80 100 120 160	K ₁	× 10 ⁴ Nm/rad	0.51	0.90	1.3	2.8	5.8
	K ₂	× 10 ⁴ Nm/rad	0.67	1.3	2.1	4.5	9.6
	K ₃	× 10 ⁴ Nm/rad	0.78	1.5	2.5	5.2	10.5
	θ ₁	arcmin	1.3	1.5	1.9	1.7	1.7
	θ ₂	arcmin	3.9	3.6	4.8	4.3	4.5

※表中数值为平均值。
Average value shown in the table

启动力矩

(封闭型, 组合型)

Starting Torque
(Closed type, Unit)

启动力矩定义

由输入侧使其旋转时, 输入侧开始旋转的力矩。

(无负荷, 环境温度: 25°C)

What is Starting Torque?

Input torque needed for input side to start rotating (no load, ambient temperature : 25°C)

加速启动力矩

(封闭型, 组合型)

Output Starting Torque
(Closed type, Unit)

加速启动力矩定义

由输出侧使其旋转时, 输出侧开始旋转的力矩。

(无负荷, 环境温度: 25°C)

What is Output Starting Torque?

Output torque needed for output side to start rotating (no load, ambient temperature : 25°C)

[cNm]

减速比 Ratio	尺寸 Size				
	35	42	50	63	80
50	2.1	3.9	7.7	17	22
80	2.0	3.4	6.6	14	21
100	1.9	3.0	6.2	12	20
120	-	2.7	5.8	11	17
160	-	-	5.3	10	16

※1 根据使用条件不同, 数值存在差异, 所以上表作为参考值使用。

※2 不包括输入侧油封及球形轴承等的旋转阻力所带来的影响。

*1 For reference only. Torque value may vary depending on the condition.

*2 Charts does not show effects due to rotation resistance of bearings and oil seals on the input side.

[Nm]

减速比 Ratio	尺寸 Size				
	35	42	50	63	80
50	1.5	2.2	3.3	8.4	16
80	1.6	2.7	3.5	10	21
100	1.8	3.2	4.2	12	24
120	-	3.4	5.6	14	27
160	-	-	6.6	20	38

※1 根据使用条件不同, 数值存在差异, 所以上表作为参考值使用。

※2 不包括输入侧油封及球形轴承等的旋转阻力所带来的影响。

*1 For reference only. Torque value may vary depending on the condition.

*2 Charts does not show effects due to rotation resistance of bearings and oil seals on the input side.

规格
Reducer Model /
Specifications

尺寸表
Dimensions Table

寿命计算
(薄壁轴承)
Life estimation
(Elastic bearing)

寿命计算
(主轴承)
Life estimation
(Main bearing)

输入轴容许
负荷
Maximum load at
input shaft

润滑剂
Lubricant information

安装精度
Attachment fixture
requirement

传动力矩
Transmitting Torque

输入部位构造
Input
section structure

注意事项
Installation and
assembly
instructions

电机安装方法
Motor installation
procedure

特性数据
Characteristics
Data

特性数据 Characteristics Data

无负荷运转力矩

(封闭型, 组合型)

No-load Running Torque
(Closed type, Unit)

无负荷运转力矩定义

在无负荷条件下, 使其旋转所需必要的输入侧力矩。

(平均值, 环境温度: 25°C)

What is No-load Running Torque?

Input torque needed to keep it running with no load
(average value, ambient temperature : 25°C)

[cNm]

减速比 Ratio	符号	尺寸 Size				
		35	42	50	63	80
50	500r/min	3.8	6.4	10	18	38
	1000r/min	4.9	7.7	12	22	54
	2000r/min	5.9	8.2	14	24	57
	3500r/min	6.3	8.7	15	26	63
80	500r/min	3.0	5.8	8.4	21	34
	1000r/min	3.7	7.4	10	24	41
	2000r/min	4.6	8.0	12	25	47
	3500r/min	5.1	8.8	12	26	53
100	500r/min	2.8	5.5	7.3	16	35
	1000r/min	3.6	7.3	9.2	19	44
	2000r/min	4.3	7.9	12	22	54
	3500r/min	4.6	8.8	13	23	57
120	500r/min	-	5.0	5.9	14	34
	1000r/min	-	5.7	8.1	18	41
	2000r/min	-	6.5	9.7	20	43
	3500r/min	-	7.2	11	21	45
160	500r/min	-	-	7.2	15	25
	1000r/min	-	-	8.9	19	30
	2000r/min	-	-	11	22	37
	3500r/min	-	-	11	22	40

※1 根据使用条件不同, 数值存在差异, 所以上表作为参考值使用。

※2 不包括输入侧油封及球形轴承等的旋转阻力所带来的影响。

*1 For reference only. Torque value may vary depending on the condition.

*2 Charts does not show effects due to rotation resistance of bearings and oil seals on the input side.

效率 (封闭型, 组合型)

Efficiency (Closed type, Unit)

负荷[%] : 负荷力矩/容许平均力矩
环境温度: 25°C

※1 图表为实测数据的平均值。

※2 不包括输入侧油封及球形轴承等的旋转阻力所带来的影响。

·Percentile Load (%) is equal to load torque divided by allowable average torque.

·Ambient temperature : 25°C

*1 These diagrams represent the average value of the actual measurement.

*2 Charts does not show effects due to rotation resistance of bearings and oil seals on the input side.

WPU-35-50

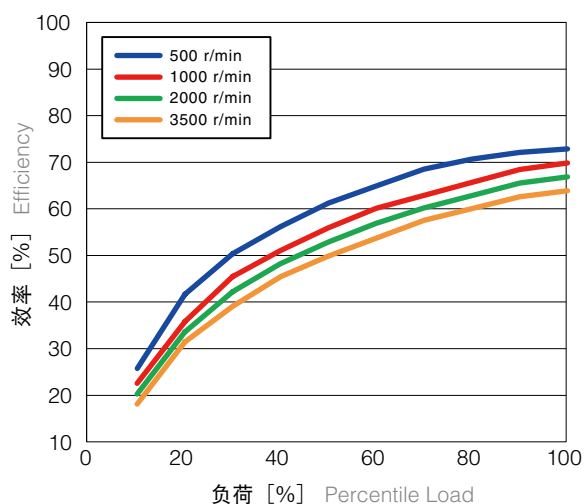

WPU-35-80

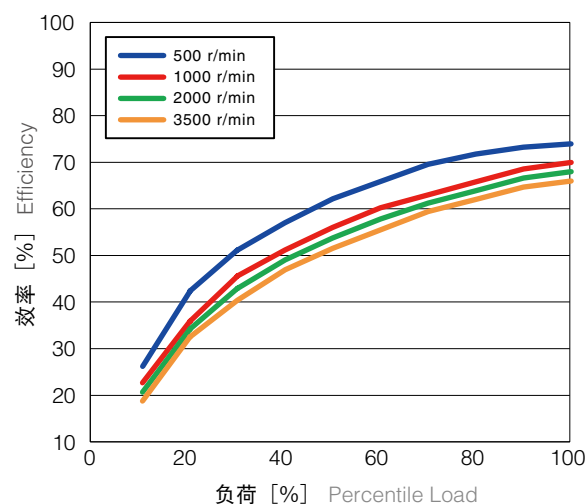

WPU-35-100

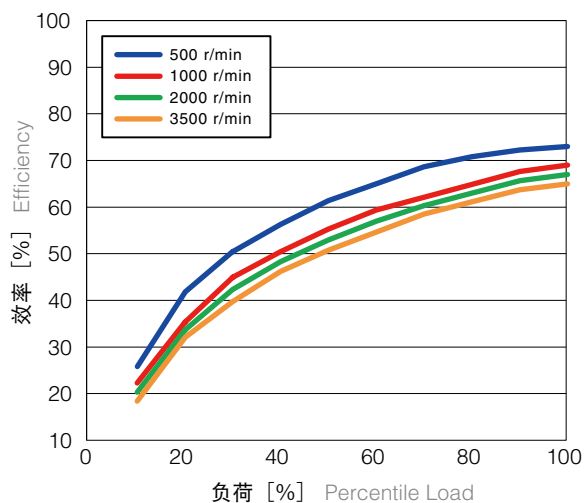

减速机型号 /
规格
Reducer Model /
Specifications

尺寸表
Dimensions Table

寿命计算
(薄壁轴承)
Life estimation
(Elastic bearing)

寿命计算
(主轴承)
Life estimation
(Main bearing)

输入轴容许
负荷
Maximum load at
input shaft

润滑剂
Lubricant information

安装精度
Attachment fixture
requirement

传力矩
Transmitting Torque

输入部位构造
Input section structure

注意事项
Installation and
assembly
instructions

电机安装方法
Motor installation
procedure

特性数据
Characteristics
Data

特性数据 *Characteristics Data*

效率 (封闭型, 组合型)

Efficiency (Closed type, Unit)

负荷[%] : 负荷力矩/容许平均力矩

环境温度: 25°C

※1 图表为实测数据的平均值。

※2 不包括输入侧油封及球形轴承等的旋转阻力所带来的影响。

·Percentile Load (%) is equal to load torque divided by allowable average torque.

·Ambient temperature : 25°C

*1 These diagrams represent the average value of the actual measurement.

*2 Charts does not show effects due to rotation resistance of bearings and oil seals on the input side.

WPU-42-50

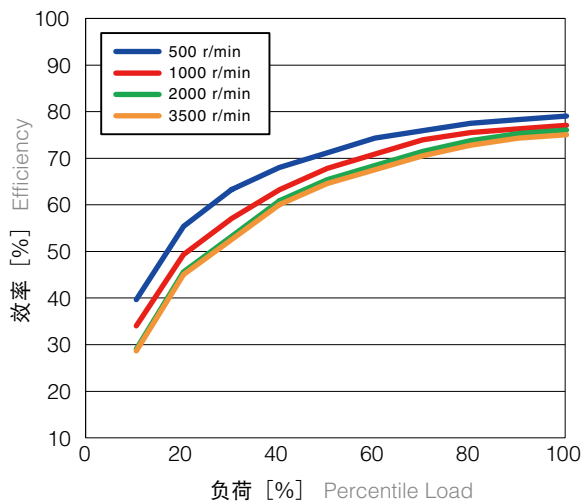

WPU-42-80

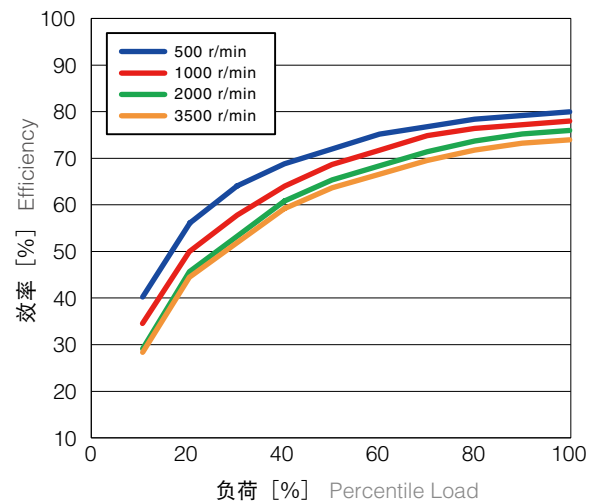

WPU-42-100

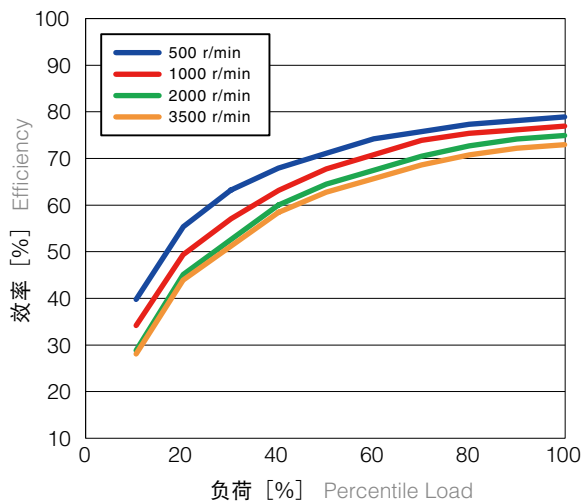

WPU-42-120

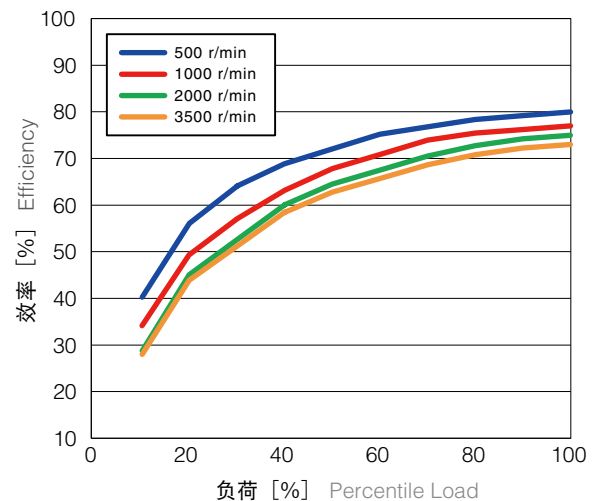

效率 (封闭型, 组合型)

Efficiency (Closed type, Unit)

负荷[%] : 负荷力矩/容许平均力矩
环境温度 : 25°C

※1 图表为实测数据的平均值。

※2 不包括输入侧油封及球形轴承等的旋转阻力所带来的影响。

·Percentile Load (%) is equal to load torque divided by allowable average torque.

·Ambient temperature : 25°C

*1 These diagrams represent the average value of the actual measurement.

*2 Charts does not show effects due to rotation resistance of bearings and oil seals on the input side.

WPU-50-50

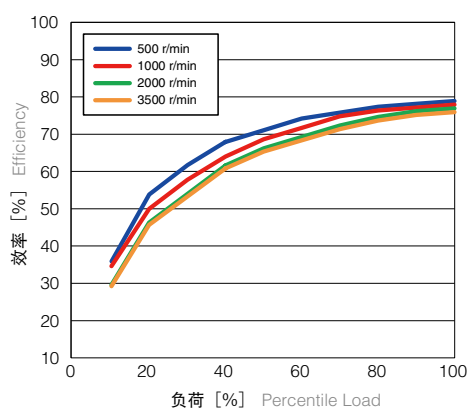

WPU-50-80

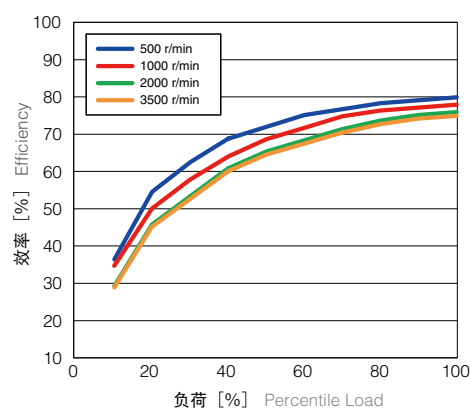

WPU-50-100

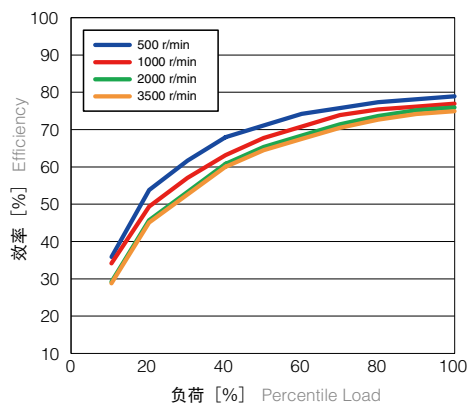

WPU-50-120

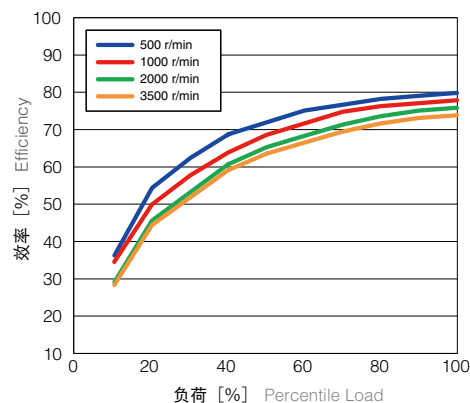

WPU-50-160

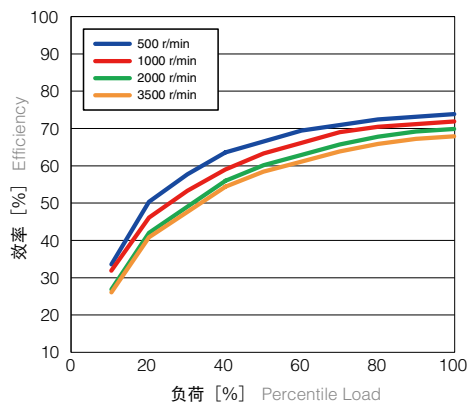

减速机型号/
规格
Reducer Model/
Specifications

尺寸表
Dimensions Table

寿命计算
(薄壁轴承)
Life estimation
(Elastic bearing)

寿命计算
(主轴承)
Life estimation
(Main bearing)

输入轴容许
负荷
Maximum load at
input shaft

润滑剂
Lubricant information

安装精度
Attachment fixture
requirement

传力力矩
Transmitting Torque

输入部位构造
Input section structure

注意事项
Installation and
assembly
instructions

电机安装方法
Motor installation
procedure

特性数据
Characteristics
Data

特性数据 Characteristics Data

效率 (封闭型, 组合型)

Efficiency (Closed type, Unit)

负荷[%] : 负荷力矩/容许平均力矩

环境温度 : 25°C

※1 图表为实测数据的平均值。

※2 不包括输入侧油封及球形轴承等的旋转阻力所带来的影响。

·Percentile Load (%) is equal to load torque divided by allowable average torque.

·Ambient temperature : 25°C

*1 These diagrams represent the average value of the actual measurement.

*2 Charts does not show effects due to rotation resistance of bearings and oil seals on the input side.

WPU-63-50

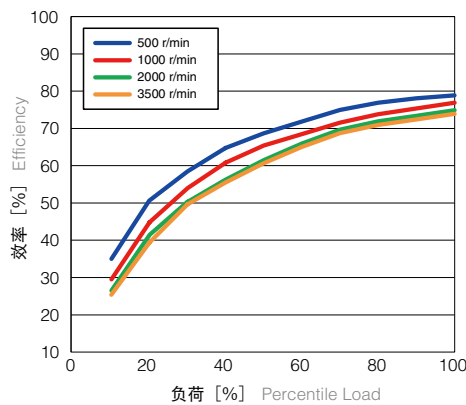

WPU-63-80

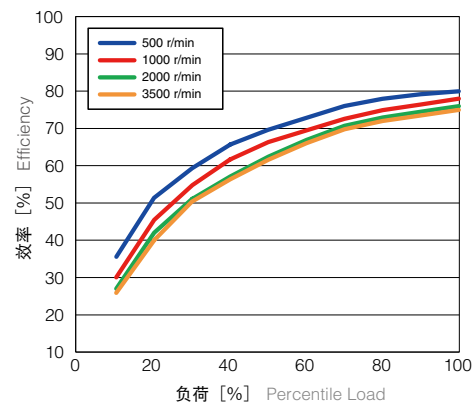

WPU-63-100

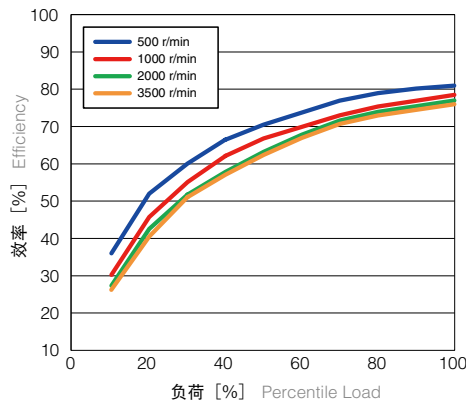

WPU-63-120

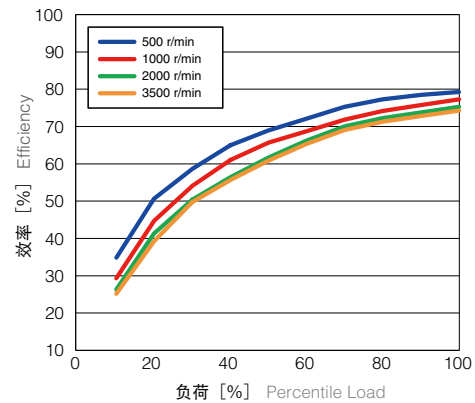

WPU-63-160

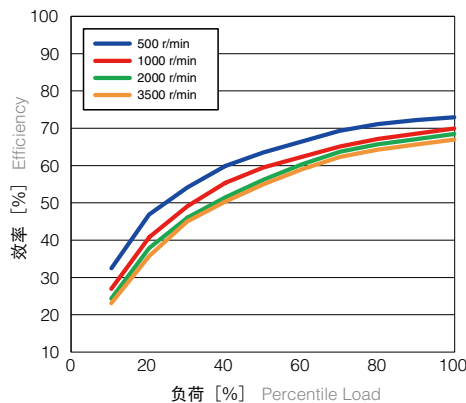

效率 (封闭型, 组合型)

Efficiency (Closed type, Unit)

负荷[%] : 负荷力矩/容许平均力矩
环境温度: 25°C

※1 图表为实测数据的平均值。

※2 不包括输入侧油封及球形轴承等的旋转阻力所带来的影响。

·Percentile Load (%) is equal to load torque divided by allowable average torque.

·Ambient temperature : 25°C

*1 These diagrams represent the average value of the actual measurement.

*2 Charts does not show effects due to rotation resistance of bearings and oil seals on the input side.

WPU-80-50

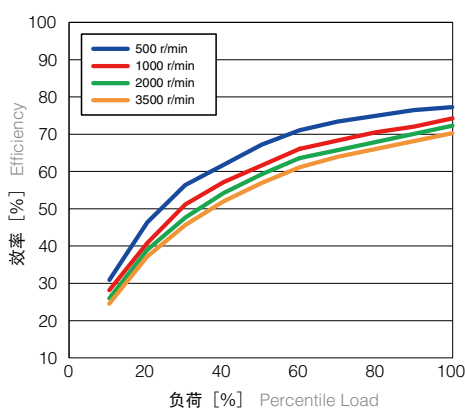

WPU-80-80

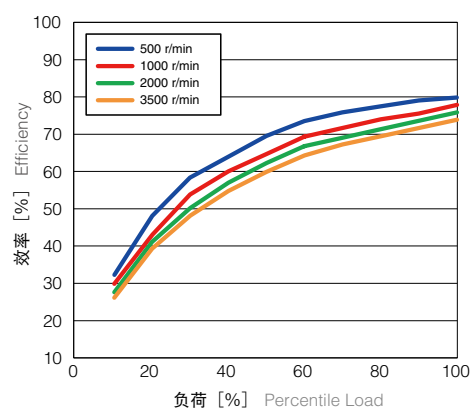

WPU-80-100

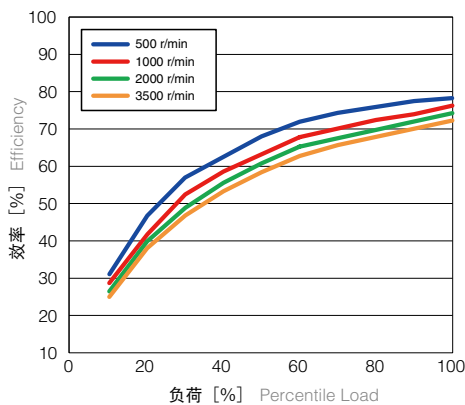

WPU-80-120

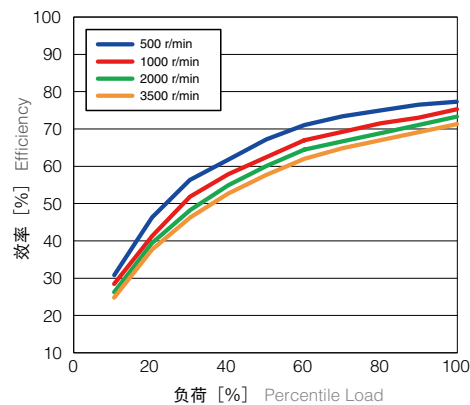

WPU-80-160

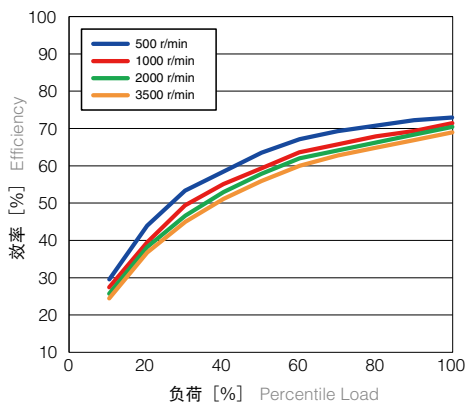

减速机型号/
规格
Reducer Model/
Specifications

尺寸表
Dimensions Table

寿命计算
(薄壁轴承)
Life estimation
(Elastic bearing)

寿命计算
(主轴承)
Life estimation
(Main bearing)

输入轴容许
负荷
Maximum load at
input shaft

润滑剂
Lubricant information

安装精度
Attachment fixture
requirement

传力力矩
Transmitting Torque

输入部位构造
Input section structure

注意事项
Installation and
assembly
instructions

电机安装方法
Motor installation
procedure

特性数据
Characteristics
Data

减速机型号 Reducer Model Nomenclature

WP	U	35	50	CD
系列名称 Series name	类型 type	尺寸 Size	减速比 Ratio	代码 [※] Code
WP系列 WP Series	C : 部件型 Component type S : 简易组合型 Simple unit type U : 组合型 组合型 (中空轴) Unit type Hollow unit	35 42 50 63 80	50 80 100 120	CD CDH SD SDH

※代码详情请参照尺寸表。
For the code details, please check the Dimensions Table.

● 段位表 Availability

Ratio matrix

Frame size	尺寸 \ 减速比	50	80	100	120
	35				
	42				
	50				
	63				
	80				



减速机规格 Reducer Specifications

尺寸 Size	减速比 Ratio R ^{※1}	※2	※3	※4	※5	※6	※7
		容许平均 力矩 Nominal output torque [Nm]	容许最大 力矩 Maximum output torque [Nm]	紧急最大 力矩 Emergency stop torque [Nm]	容许平均 输入转速 Nominal input speed [r/min]	容许最高 输入转速 Maximum input speed [r/min]	寿命时间 Life [hours]
35	50	3.7	12	24	3000	8500	7000
	80	5.4	16	29			
	100	5.4	19	31			
42	50	11	23	48	3000	7300	
	80	15	29	52			
	100	16	37	55			
	120	16	37	55			
50	50	17	39	69	3000	6500	
	80	24	51	75			
	100	28	57	76			
	120	28	57	76			
63	50	27	69	127	3000	5600	
	80	44	96	147			
	100	47	110	152			
	120	47	110	152			
80	50	53	151	268	3000	4800	
	80	82	212	334			
	100	96	233	359			
	120	96	233	359			

※1 请将R值代入P.4所述公式内, 求得减速比

※2 输入转速为2000r/min 时的容许最大值

※3 启动、停止时的容许最大值

※4 发生撞击时的容许最大值

※5 运转过程中, 平均输入转速的容许最大值

※6 运转过程中, 输入转速的容许最大值

※7 输入转速2000r/min, 容许额定力矩负荷时的寿命时间

*1 Reduction ratio is to be calculated by the formula in the previous page, using R value in this table.

*2 The maximum allowable value at the input rotation speed of 2000r/min

*3 The maximum torque when starting and stopping.

*4 The maximum torque when it receives shock.

*5 The maximum average input speed.

*6 The maximum input speed.

*7 The life time at the input rotation speed of 2000 r/min and nominal output torque.

尺寸表 *Dimensions Table*

封闭型 部件型
Closed Type, Component

WPC-□-□-CD

尺寸 Size	重量 Weight	惯性力矩 Moment of inertia
	kg	$\times 10^{-4} \text{kgm}^2$
35	0.062	0.0226
42	0.10	0.0565
50	0.16	0.113
63	0.26	0.342
80	0.57	1.18

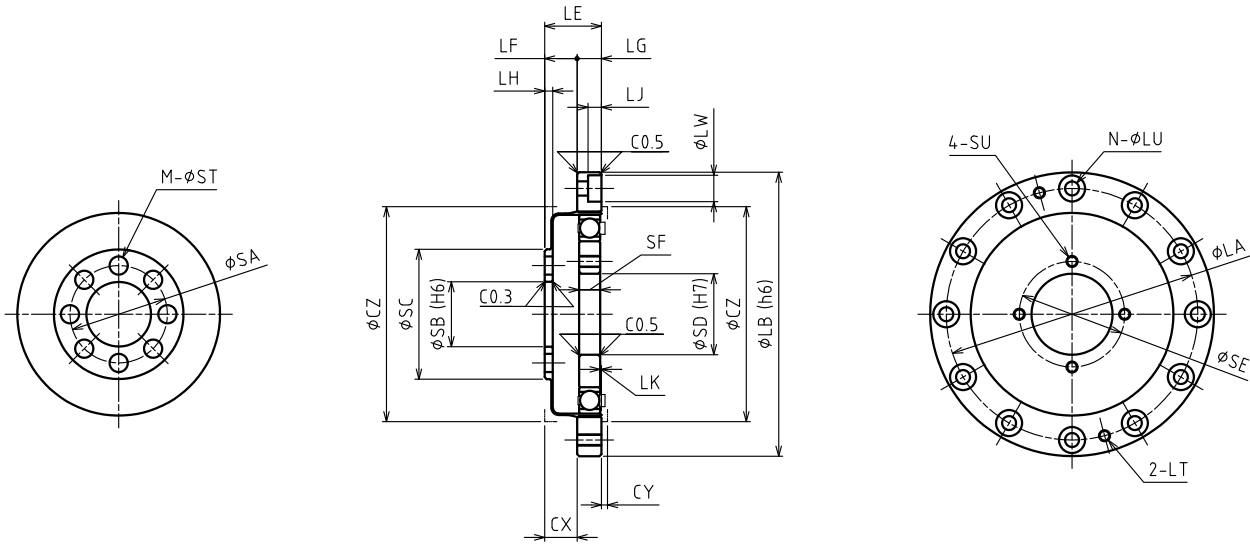

尺寸 Size	LA	LB	LE	LF	LG	LH	LJ	LK	N	LU	LW	LT
35	44	50	11	6.5	4.5	1.4	-	0.3	6	3.5	-	M3
42	54	60	12.5	7.5	5	1.7	-	0.3	8	3.5	-	M3
50	62	70	14	8	6	2	3.3	0.3	12	3.5	6.5	M3
63	75	85	17	10	7	2	3.3	0.4	12	3.5	6.5	M3
80	100	110	22	13	9	2.5	4.4	0.5	12	4.5	8	M4

尺寸 Size	SA	SB	SC	SD	SE	SF	CX	CY	CZ	M	ST	SU
35	17	11	23.5	11	17	4	6.5	1	38	8	3.5	M3
42	19.5	11	27	15	21	5	7.5	1	45	8	4.5	M3
50	24	16	32	20	26	5.2	8	1.5	53	8	4.5	M3
63	30	20	40	24	30	6.3	10	1.5	66	8	5.5	M3
80	41	30	52	32	40	8.6	13	2	86	10	6.5	M4

※ CX、CY、CZ为护罩内壁建议尺寸。

*Inner dimensions of CX, CY, CZ are recommended dimensions.

减速机型号/
规格
Reducer Model/
Specifications

尺寸表
Dimensions Table

寿命计算 (薄壁轴承) /
寿命计算 (主轴承)
Life estimation (Elastic bearing) /
Life estimation (Main bearing)

输入轴容许负荷 /
润滑油
Maximum load at
input shaft /
lubricant information

安装精度
Attachment fixture
requirement

传导力矩
Transmitting Torque

注意事项
Installation and
assembly instructions

特性数据
Characteristics Data

尺寸表 Dimensions Table

封闭型 组合型
Closed Type, Unit

WPU-□ - □ -CD

尺寸 Size	重量 Weight	惯性力矩 Moment of inertia
	kg	$\times 10^{-4} \text{kgm}^2$
35	0.33	0.0227
42	0.43	0.0565
50	0.61	0.113
63	1.1	0.343
80	2.2	1.18

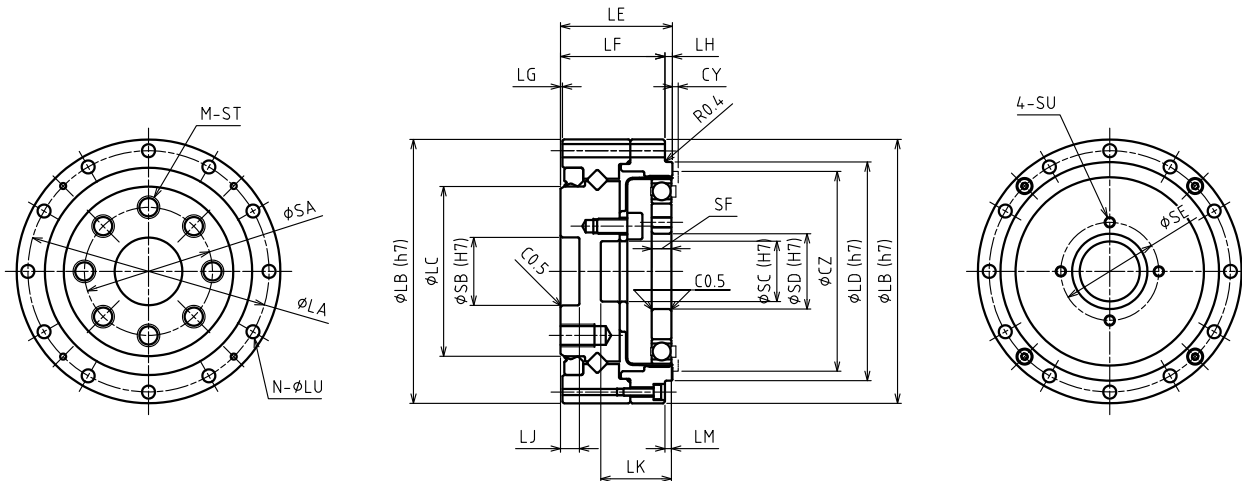

[mm]

尺寸 Size	LA	LB	LC	LD	LE	LF	LG	LH	LJ	LK	LM	N	LU
35	49	55	31	42.5	25	23	0.5	2	5	14.7	1.7	6	3.5
42	56	62	38	49.5	26.5	24.5	0.5	2	5	16.2	1.7	10	3.5
50	64	70	45	58	29.7	27.7	0.5	2	5	18.7	1.7	12	3.5
63	79	85	58	73	37.1	34.1	0.5	3	5.5	23.6	2.6	18	3.5
80	104	112	78	96	43	40	1	3	5.5	30.5	2.5	18	4.5

尺寸 Size	SA	SB	SC	SD	SE	SF	CY	CZ	M	ST	SU
35	25	12	11	11	17	4	1	38	10	M3 × 6	M3
42	27	14	11	15	21	5	1	45	8	M5 × 8	M3
50	34	18	16	20	26	5.2	1.5	53	8	M6 × 9	M3
63	42	24	20	24	30	6.3	1.5	66	8	M8 × 12	M3
80	57	32	30	32	40	8.6	2	86	10	M8 × 12	M4

※ CY、CZ为护罩内壁建议尺寸。

*Inner dimensions of CY, CZ are recommended dimensions.

封闭型 组合型
Closed Type, Unit

WPU-□-□-CDH

尺寸 Size	重量 Weight	惯性力矩 Moment of inertia
	kg	$\times 10^{-4} \text{kgm}^2$
35	0.46	0.0228
42	0.63	0.0571
50	0.91	0.113
63	1.6	0.344
80	3.0	1.18

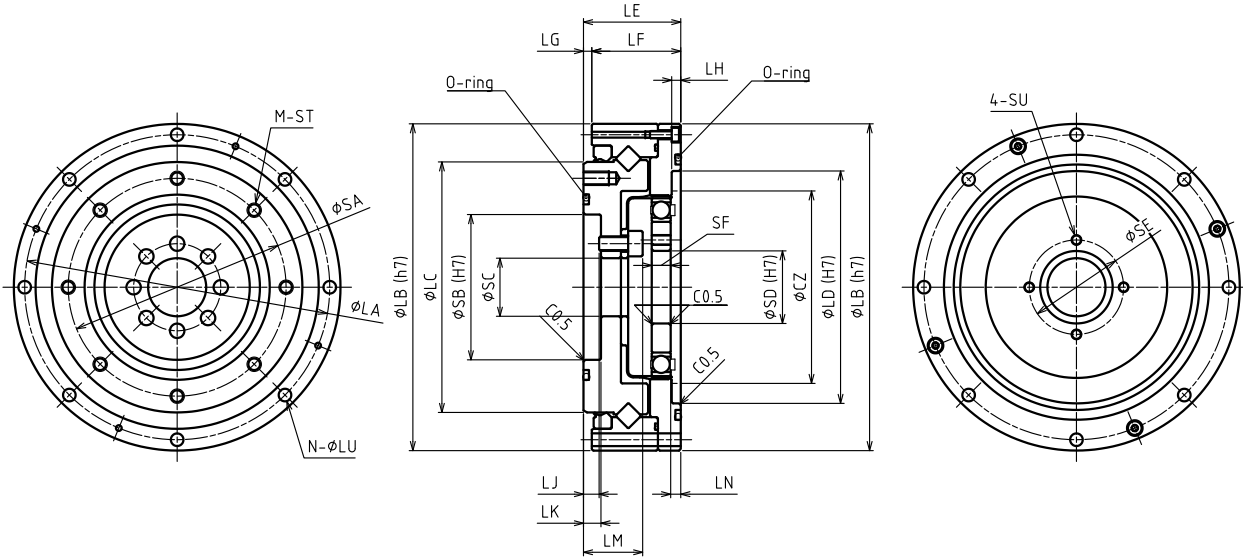

[mm]

尺寸 Size	LA	LB	LC	LD	LE	LF	LG	LH	LJ	LK	LM	LN	N	LU
35	64	70	49	48	22	21.5	0.5	2.5	3.9	4.9	12.9	2.8	6	3.5
42	74	80	59	56	22.7	22.2	0.5	2.5	1.4	3.7	13.4	2.8	8	3.5
50	84	90	69	64	26.8	24.5	2.3	2.5	4.3	4.8	16.3	2.8	8	3.5
63	102	110	84	80	31.5	29.4	2.1	3	3.5	5.5	18.5	3.4	10	4.5
80	132	142	110	106	37	34.2	2.8	3	2.5	6	20.5	3.5	10	5.5

尺寸 Size	SA	SB	SC	SD	SE	SF	CZ	M	ST	SU
35	42	30	11	11	17	4	38	8	M3 × 5	M3
42	50	34	11	15	21	5	45	10	M3 × 6	M3
50	60	40	16	20	26	5.2	53	8	M4 × 7	M3
63	73	52	20	24	30	6.3	66	8	M5 × 8	M3
80	96	70	30	32	40	8.6	86	8	M6 × 10	M4

※ CZ为护罩内壁建议尺寸。

*Inner dimensions of CZ are recommended dimensions.

减速机型号/
规格
Reducer Model/
Specifications

尺寸表
Dimensions Table

寿命计算(薄壁轴承)/
寿命计算(主轴承)
Life estimation
(Elastic bearing) /
Life estimation (Main bearing)

输入轴容许负荷/
润滑油
Maximum load at
input shaft /
Lubricant information

安装精度
Attachment fixture
requirement

传导力矩
Transmitting Torque

注意事项
Installation and
assembly instructions

特性数据
Characteristics Data

尺寸表 Dimensions Table

开放型 简易组合型
Open type, Simple unit

WPS-□-□-SD

尺寸 Size	重量 Weight	惯性力矩 Moment of inertia
	kg	$\times 10^{-4} \text{kgm}^2$
35	0.31	0.0233
42	0.43	0.0578
50	0.54	0.114
63	0.93	0.347
80	2.0	1.20

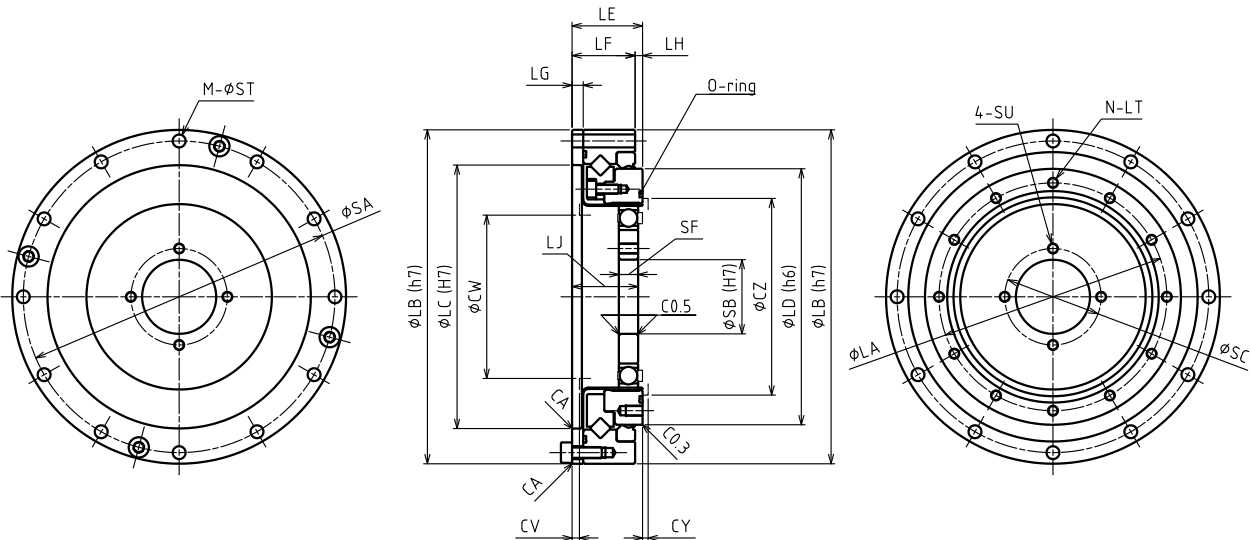

[mm]

尺寸 Size	LA	LB	LC	LD	LE	LF	LG	LH	LJ	N	LT
35	43	70	50	49	17.5	15.5	2.4	2	15.7	8	M3 × 4.5
42	52	80	61	59	18.5	16.5	3	2	16.9	12	M3 × 4.5
50	61.4	90	71	69	19	17	3	2	17.8	12	M3 × 4.5
63	76	110	88	84	22	20	3.3	2	21.6	12	M4 × 6
80	99	142	114	110	27.9	23.6	3.6	4.3	27.3	12	M5 × 8

尺寸 Size	SA	SB	SC	SF	CA	CY	CZ	CV	CW	M	ST	SU
35	64	11	17	4	0.3	1	36.5	1.6	31	8	3.5	M3
42	74	15	21	5	0.3	1	43.5	2	37	12	3.5	M3
50	84	20	26	5.2	0.3	1.5	53	2	44	12	3.5	M3
63	102	24	30	6.3	0.3	1.5	66	2	56	12	4.5	M3
80	132	32	40	8.6	0.5	2	84	2	72	12	5.5	M4

※ CV、CW、CY、CZ 为护罩内壁建议尺寸。

*Inner dimensions of CV, CW, CY, CZ are recommended dimensions.

开放型 组合型 (中空轴)
Open type, Unit (hollow shaft)

WPU-□-□-SDH

尺寸 Size	重量 Weight	惯性力矩 Moment of inertia
	kg	$\times 10^{-4} \text{kgm}^2$
35	0.49	0.0839
42	0.66	0.180
50	0.84	0.352
63	1.4	0.940
80	2.8	3.47

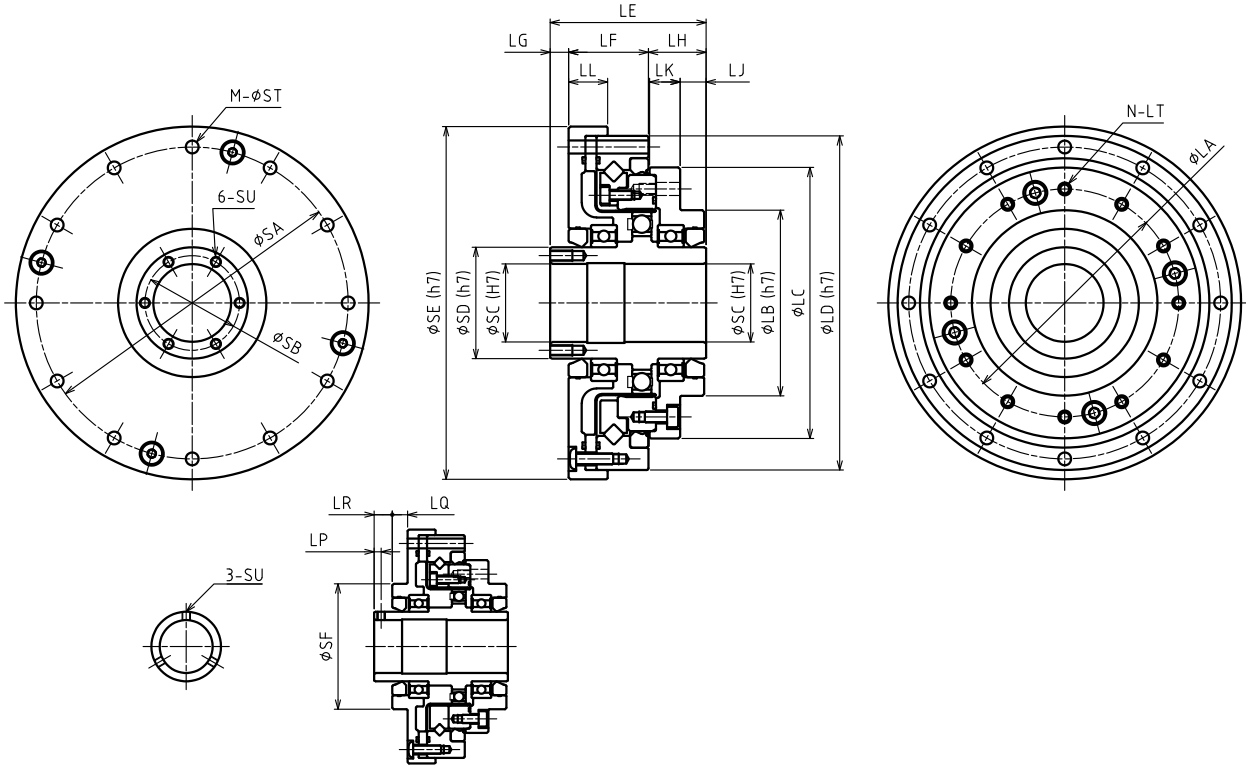

INPUT SHAFT FOR 35&42

尺寸 Size	LA	LB	LC	LD	LE	LF	LG	LH	LJ	LK	LL	LP	LQ	LR
35	43	36	52	70	45.5	19.5	12	14	6.5	7.5	9	2.5	5.5	6.5
42	52	45	62	80	48	20.5	12	15.5	7	8.5	10	2.5	5.5	6.5
50	61.4	50	73	90	42	21.5	5	15.5	7	8.5	10.5	-	-	-
63	76	60	87	110	46.5	24	6	16.5	6	10.5	10.5	-	-	-
80	99	75	114	142	55	28.6	7	19.4	7.5	11.9	12	-	-	-

尺寸 Size	SA	SB	SC	SD	SE	SF	M	ST	SU	N	LT
35	64	-	14	20	74	36	8	3.5	M3	8	M3 × 4.5, ϕ 3.5 × 5.5
42	74	-	19	25	84	45	12	3.5	M3	12	M3 × 4.5, ϕ 3.5 × 6.5
50	84	25.5	21	30	95	-	12	3.5	M3 × 6	12	M3 × 4.5, ϕ 3.5 × 6.5
63	102	33.5	29	38	115	-	12	4.5	M3 × 6	12	M4 × 6, ϕ 4.5 × 8.5
80	132	48	41	54	147	-	12	5.5	M3 × 6	12	M5 × 8, ϕ 5.5 × 7.6

寿命计算（薄壁轴承） *Life estimation (Elastic bearing)*

薄壁轴承寿命计算

Life span for the elastic bearing

■ 运转类型

Operation cycle example

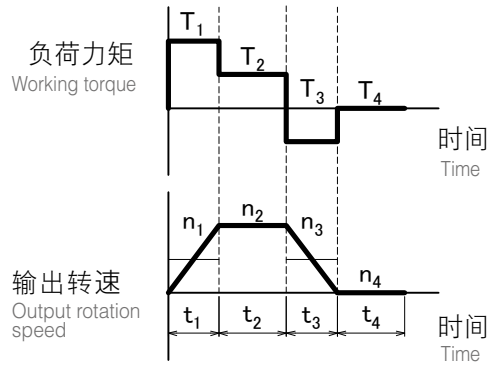

① 平均输出力矩 / 最大输出力矩的计算

Calculation formula for output torque

平均输出力矩 Average output torque	T _{ao}	Nm	$T_{ao} = \sqrt[3]{\frac{n_1 \cdot t_1 \cdot T_1 ^3 + n_2 \cdot t_2 \cdot T_2 ^3 + \dots + n_n \cdot t_n \cdot T_n ^3}{n_1 \cdot t_1 + n_2 \cdot t_2 + \dots + n_n \cdot t_n}}$
最大输出力矩 Peak output torque value	T _{mo}	Nm	T _{mo} = T ₁ , T ₂ , ... T _n 的最大值 T _{mo} = Largest among T ₁ , T ₂ , ... T _n

请确认最大输出力矩为容许最大输出值以下

Please make sure the peak output torque is below the maximum output torque in the specification table

② 平均输入转速 / 最高输入转速的计算

Calculation formula for input speed

平均输出转速 Average output rotation speed	nao	r/min	$nao = \frac{n_1 \cdot t_1 + n_2 \cdot t_2 + \dots + n_n \cdot t_n}{t_1 + t_2 + \dots + t_n}$
最高输出转速 Peak output rotation speed	nmo	r/min	nmo = n ₁ , n ₂ , ... n _n 的最大值 nmo = Largest among n ₁ , n ₂ , ... n _n
平均输入转速 Average input speed	nai	r/min	nai = nao × R (R = 减速比) (R = ratio)
最高输入转速 Peak input speed value	nmi	r/min	nmi = nmo × R (R = 减速比) (R = ratio)

请确认最高输入转速为容许最高输入转速值以下

Please make sure the peak input speed value is below the maximum input speed in the specification table

③ 寿命时间的计算

Calculation formula for life span

薄壁轴承寿命时间 Part life span for the elastic bearing	Lhe	h	$Lhe = 7000 \times \left(\frac{Tar}{Tao}\right)^3 \times \left(\frac{nar}{nai}\right)$
额定力矩 Rating torque	Tar	Nm	性能表中所记容许平均力矩 Nominal output torque in the specification table
额定输入转速 Rating input rotation speed	nar	r/min	2000 r/min

寿命计算 (主轴承) *Life estimation(Main bearing)*

型号选定/寿命计算 *Model selection / Life estimation*

■ 主轴承规格 (交叉滚子轴承) *Main bearing specification(Cross roller bearing)*

系列 Series	尺寸 Size	滚轴节圆直径 Pitch circle diameter of the bearing rollers	偏移量 Offset	基本动态额定负荷 Basic dynamic load rating	基本静态额定负荷 Basic static load rating	容许力矩 Allowable moment	力矩刚性 Moment rigidity
		Dm	L	C	Co	Mal	Km
		m	m	N	N	Nm	× 10 ⁴ Nm/rad
WPU-□-□-CD	35	0.0335	0.0090	5620	6540	36.5	7.35
	42	0.0410	0.0095	6340	8170	55.8	8.02
	50	0.0493	0.0105	10400	13300	91.0	13.5
	63	0.0615	0.0128	15800	21100	156	27.7
	80	0.0815	0.0130	24400	35600	313	66.0
WPU-□-□-CDH	35	0.0505	0.0062	7110	10200	74.0	14.4
	42	0.0598	0.0066	10900	15200	124	19.7
	50	0.0708	0.0077	17200	24700	187	40.1
	63	0.0856	0.0092	25100	37400	258	71.5
	80	0.114	0.0106	43300	67600	580	188
WPS-□-□-SD	35	0.0512	0.0111	8010	11400	37.0	8.86
	42	0.0614	0.0112	7370	10900	62	20.8
	50	0.0715	0.0114	8030	12800	93	22.5
	63	0.0869	0.0128	14300	24500	129	33.3
	80	0.113	0.0181	23700	42500	290	84.5
WPU-□-□-SDH	35	0.0512	0.0166	8010	11400	37.0	8.86
	42	0.0614	0.0177	7370	10900	62	20.8
	50	0.0715	0.0179	8030	12800	93	22.5
	63	0.0869	0.0213	14300	24500	129	33.3
	80	0.113	0.0257	23700	42500	290	84.5

■ 外部负荷 External load

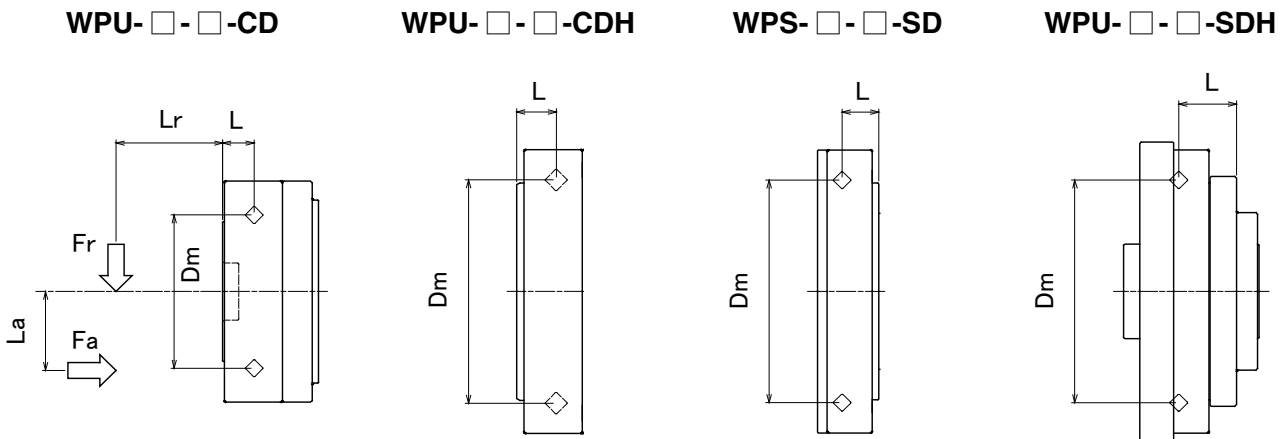

减速机型号/
规格
Reducer Model /
Specifications

尺寸表
Dimensions Table

寿命计算 (薄壁轴承) /
寿命计算 (主轴承)
Life estimation
(Elastic bearing) /
Life estimation (Main bearing)

输入轴容许负荷 /
润滑油
Maximum load at
input shaft /
lubricant information

安装精度
Attachment fixture
requirement

传导力矩
Transmitting Torque

注意事项
Installation and
assembly instructions

特性数据
Characteristics Data

输入轴容许负荷 *Maximum load at input shaft*

■ 轴承规格（开放型，组合型） Bearing specification (Open type, Unit)

系列 Series	尺寸 Size	轴承 A Bearing A		轴承 B Bearing B		a	b
		基本动态额定负荷 Basic dynamic load rating	基本静态额定负荷 Basic static load rating	基本动态额定负荷 Basic dynamic load rating	基本静态额定负荷 Basic static load rating		
		C	Co	C	Co		
		N	N	N	N	mm	mm
WPU-□-□-SDH	35	4000	2470	4000	2470	16.0	20.0
	42	4300	2950	4300	2950	16.0	22.5
	50	4500	3450	4500	3450	14.5	18.0
	63	4900	4350	4900	4350	15.5	21.8
	80	8800	8500	6400	6200	17.0	28.5

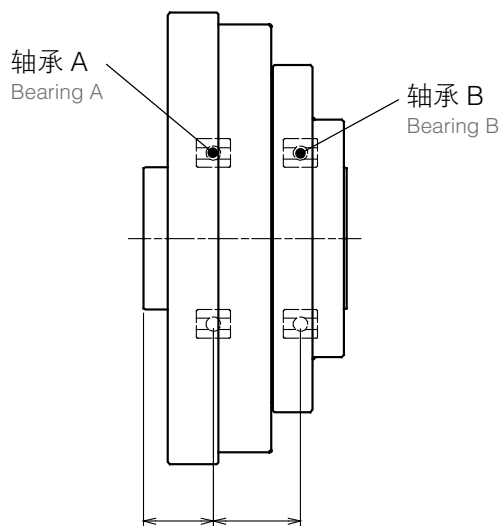

■ 容许负荷（平均输入转速：2000r/min、寿命时间：7000h）

Maximum load (Average input rotation speed : 2000r/min, Life span : 7000h)

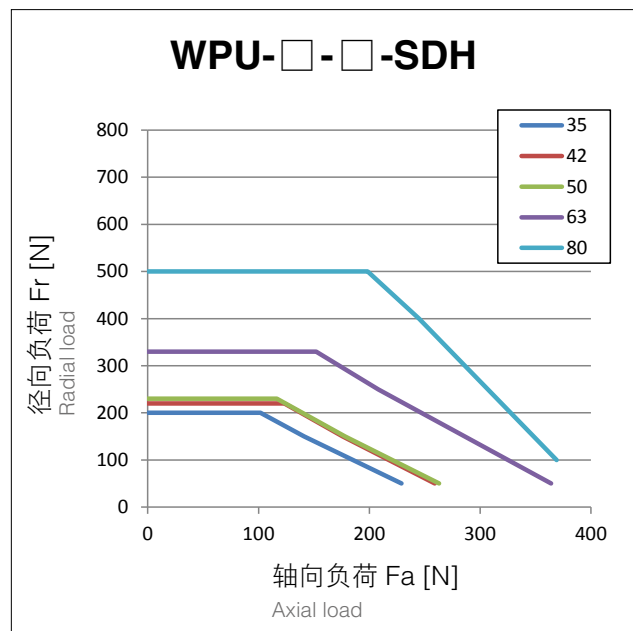

润滑剂 *lubricant information*

润滑剂的使用

Grease

Sumiplex MP No.2 (日本住矿润滑剂株式会社) Sumiplex MP No.2 (SUMICO LUBRICANT CO., LTD.)

使用温度范围: 0 ~ 40°C (环境温度) Operating temperature range: 0-40°C (ambient temperature)

润滑剂的涂抹

Grease application

按照以下要求在减速机各部位涂抹润滑剂。 Please apply grease according to the table below.

■ 润滑剂涂抹量 Grease application

- 根据减速机的安装方向（输出侧为横向、向上、向下）不同，变更涂抹部位C的涂抹量。（已封入润滑油的组合类型，填充了C（横向）的润滑油量。）
- 减速机为向上、向下时，请填写输入ASSY~护罩内壁空间的50%的润滑剂。
- 由于护罩设计造成润滑剂不足时，请咨询本公司。

The quantity of grease applied to C should be adjusted depending on the mounting direction. C of the unit type product is already filled with the same quantity of grease as horizontal mounting.

For vertical up/down, 50% of the space between input assy and casing inner wall should be filled with grease.

If the amount of grease is not sufficient due to case design, please contact us.

尺寸 Size	涂抹部位 Applied part					
	A	B	C (横向) Horizontal	C (向上) Vertical up	C (向下) Vertical down	D
35	0.2	0.2	3	4	5	0.2
42	0.3	0.3	5	6	7	0.3
50	0.4	0.4 </td <td>8</td> <td>9</td> <td>11</td> <td>0.4</td>	8	9	11	0.4
63	0.8	0.8	16	19	21	0.8
80	1.5	1.5	36	42	48	1.5

■ 润滑剂涂抹部位 Grease application location

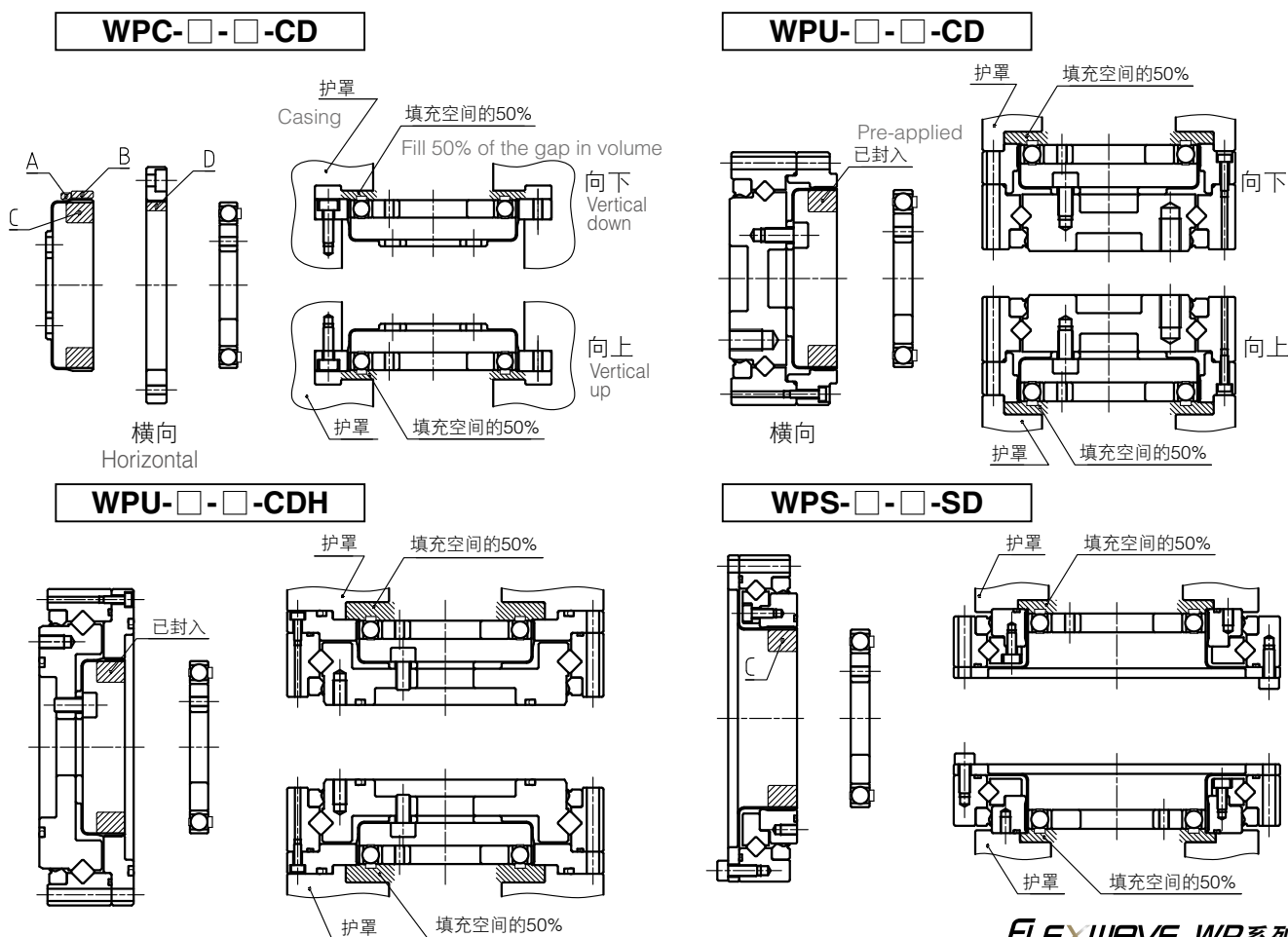

减速机型号/
规格
Reducer Model/
Specifications

尺寸表
Dimensions Table

寿命计算(薄壁轴承)/
寿命计算(主轴承)
Life estimation
(Elastic bearing)/
Life estimation (Main bearing)

输入轴容许负荷/
润滑剂
Maximum load at
Input shaft/
Lubricant information

安装精度
Attachment fixture
requirement

传导力矩
Transmitting Torque

注意事项
Installation and
assembly instructions

特性数据
Characteristics Data

安装精度 Attachment fixture requirement

■ 安装精度 Attachment fixture requirement

WPC-□-□-CD

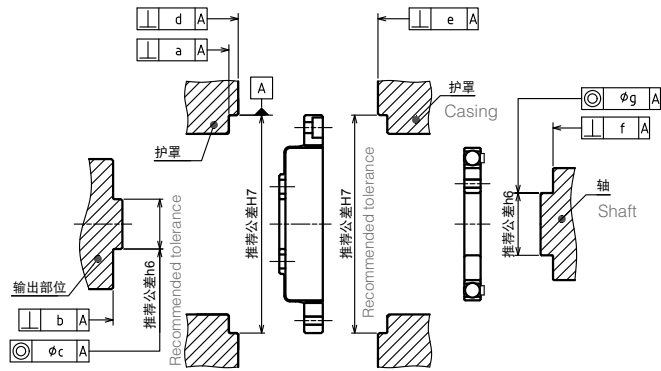

安装精度 [mm]

尺寸 Size	35	42	50	63	80
a	0.015	0.015	0.018	0.018	0.023
b	0.010	0.012	0.014	0.016	0.020
c	0.013	0.013	0.015	0.018	0.020
d	0.015	0.015	0.018	0.018	0.023
e	0.015	0.015	0.018	0.018	0.023
f	0.012	0.012	0.014	0.016	0.016
g	0.016	0.020	0.024	0.024	0.024

WPU-□-□-CD

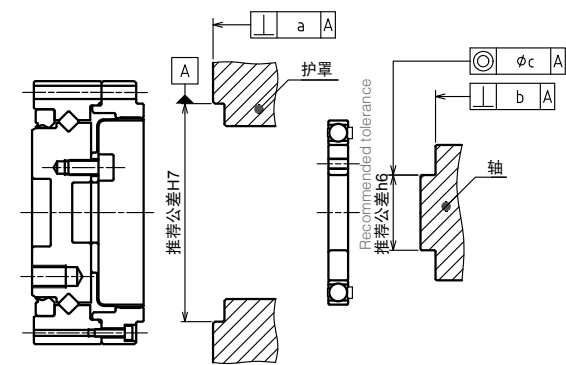

安装精度 [mm]

尺寸 Size	35	42	50	63	80
a	0.020	0.020	0.020	0.025	0.025
b	0.012	0.012	0.014	0.016	0.016
c	0.016	0.020	0.024	0.024	0.024

WPU-□-□-CDH

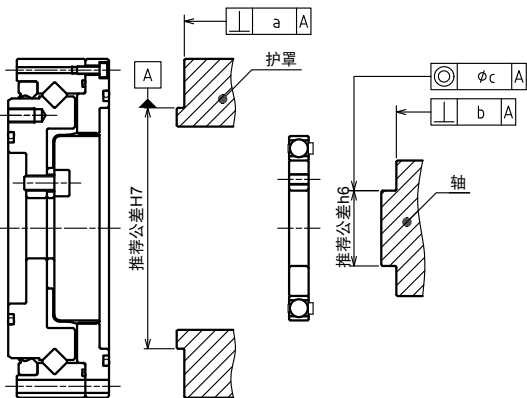

安装精度 [mm]

尺寸 Size	35	42	50	63	80
a	0.020	0.020	0.020	0.025	0.025
b	0.012	0.012	0.014	0.016	0.016
c	0.016	0.020	0.024	0.024	0.024

WPS-□-□-SD

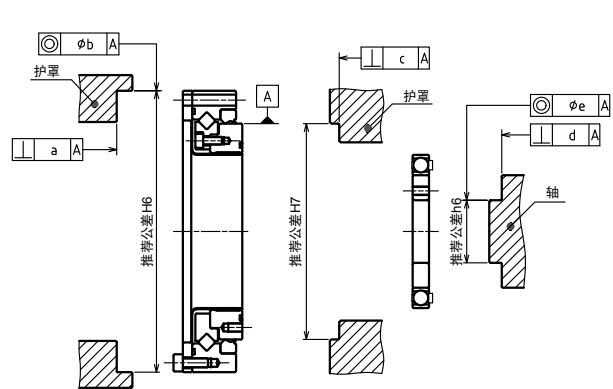

安装精度 [mm]

尺寸 Size	35	42	50	63	80
a	0.020	0.020	0.020	0.025	0.025
b	0.020	0.020	0.020	0.025	0.025
c	0.020	0.020	0.020	0.025	0.025
d	0.012	0.012	0.014	0.016	0.016
e	0.016	0.020	0.024	0.024	0.024

传导力矩 *Transmitting Torque*

安装螺丝

螺丝紧固力矩如下表所示。

Bolting

Please refer to the table below for the bolt tightening torque.

螺丝紧固力矩

Tightening torque for bolts

螺丝尺寸	Bolt size	M3	M4	M5	M6	M8	M10
紧固力矩 [Nm]	Tightening torque	1.9	4.3	8.7	15	36	71

建议螺丝：强度区分12.9以上

Recommended bolt : Strength rating above 12.9

传导力矩（封闭型、组合型）

Bolt specifications and Transmitting torque (Closed type, Unit)

安装输出法兰（WPU-□-□-CD） Output flange attachment

尺寸	Size	35	42	50	63	80
螺丝尺寸	Bolt size	M3	M5	M6	M8	M8
螺丝个数	Bolt count	10	8	8	8	10
安装PCD [mm]	Bolt PCD	25	27	34	42	57
紧固力矩 [Nm]	Tightening torque	1.9	8.7	15	36	36
传导力矩 [Nm]	Transmitting torque	58	141	252	566	960

安装内齿轮（WPU-□-□-CD） Internal gear attachment

尺寸	Size	35	42	50	63	80
螺丝尺寸	Bolt size	M3	M3	M3	M3	M4
螺丝个数	Bolt count	6	10	12	18	18
安装PCD [mm]	Bolt PCD	49	56	64	79	104
紧固力矩 [Nm]	Tightening torque	1.9	1.9	1.9	1.9	4.3
传导力矩 [Nm]	Transmitting torque	68	130	178	330	757

安装输出法兰（WPU-□-□-CDH） Output flange attachment

尺寸	Size	35	42	50	63	80
螺丝尺寸	Bolt size	M3	M3	M4	M5	M6
螺丝个数	Bolt count	8	10	8	8	8
安装PCD [mm]	Bolt PCD	42	50	60	73	96
紧固力矩 [Nm]	Tightening torque	1.9	1.9	4.3	8.7	15
传导力矩 [Nm]	Transmitting torque	78	116	194	382	713

安装内齿轮（WPU-□-□-CDH） Internal gear attachment

尺寸	Size	35	42	50	63	80
螺丝尺寸	Bolt size	M3	M3	M3	M4	M5
螺丝个数	Bolt count	6	8	8	10	10
安装PCD [mm]	Bolt PCD	64	74	84	102	132
紧固力矩 [Nm]	Tightening torque	1.9	1.9	1.9	4.3	8.7
传导力矩 [Nm]	Transmitting torque	89	137	156	412	864

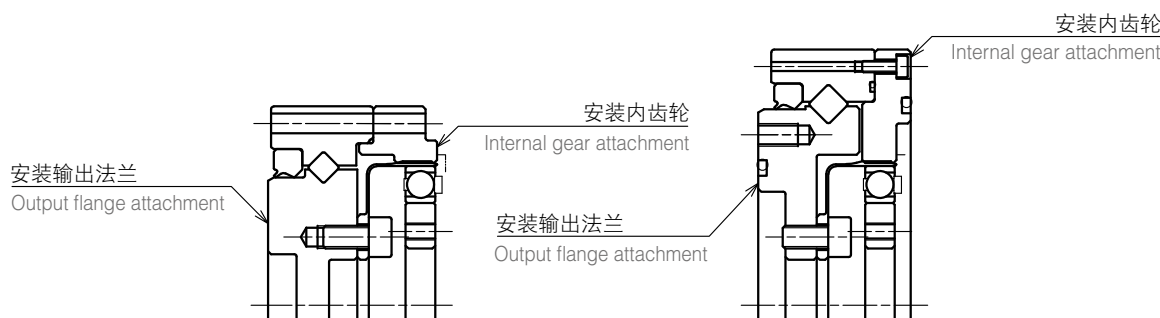

规格
Reducer Model / Specifications

尺寸表
Dimensions Table

寿命计算（薄壁轴承 / 寿命计算（主轴承））
Life estimation (Elastic bearing) / Life estimation (Main bearing)

输入轴容许负荷 / 润滑油
Maximum load at input shaft / Lubricant information

安装精度
Attachment fixture requirement

传导力矩
Transmitting Torque

注意事项
Installation and assembly instructions

特性数据
Characteristics Data

传力矩 *Transmitting Torque*

传力矩 (封闭型、部件型)

Bolt specifications and Transmitting torque (Closed type, Component)

安装柔性齿轮 *Flex gear attachment*

尺寸	Size	35	42	50	63	80
螺丝尺寸	Bolt size	M3	M4	M4	M5	M6
螺丝个数	Bolt count	8	8	8	8	10
安装PCD [mm]	Bolt PCD	17	19.5	24	30	41
紧固力矩 [Nm]	Tightening torque	1.9	4.3	4.3	8.7	15
传力矩 [Nm]	Transmitting torque	32	63	78	157	380

安装内齿轮 *Internal gear attachment*

尺寸	Size	35	42	50	63	80
螺丝尺寸	Bolt size	M3	M3	M3	M3	M4
螺丝个数	Bolt count	6	8	12	12	12
安装PCD [mm]	Bolt PCD	44	54	62	75	100
紧固力矩 [Nm]	Tightening torque	1.9	1.9	1.9	1.9	4.3
传力矩 [Nm]	Transmitting torque	61	100	172	209	485

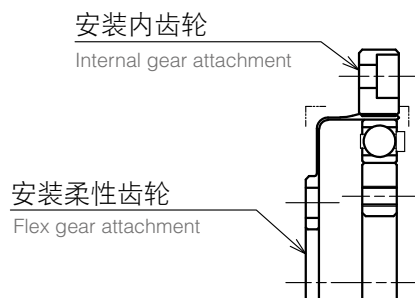

传力矩 (开放型)

Bolt specifications and Transmitting torque (Open type)

安装柔性齿轮 *Flex gear attachment*

尺寸	Size	35	42	50	63	80
螺丝尺寸	Bolt size	M3	M3	M3	M4	M5
螺丝个数	Bolt count	8	12	12	12	12
安装PCD [mm]	Bolt PCD	64	74	84	102	132
紧固力矩 [Nm]	Tightening torque	1.9	1.9	1.9	4.3	8.7
传力矩 [Nm]	Transmitting torque	119	206	234	495	1037

安装内齿轮 *Internal gear attachment*

尺寸	Size	35	42	50	63	80
螺丝尺寸	Bolt size	M3	M3	M3	M4	M5
螺丝个数	Bolt count	8	12	12	12	12
安装PCD [mm]	Bolt PCD	43	52	61.4	76	99
紧固力矩 [Nm]	Tightening torque	1.9	1.9	1.9	4.3	8.7
传力矩 [Nm]	Transmitting torque	80	145	171	369	778

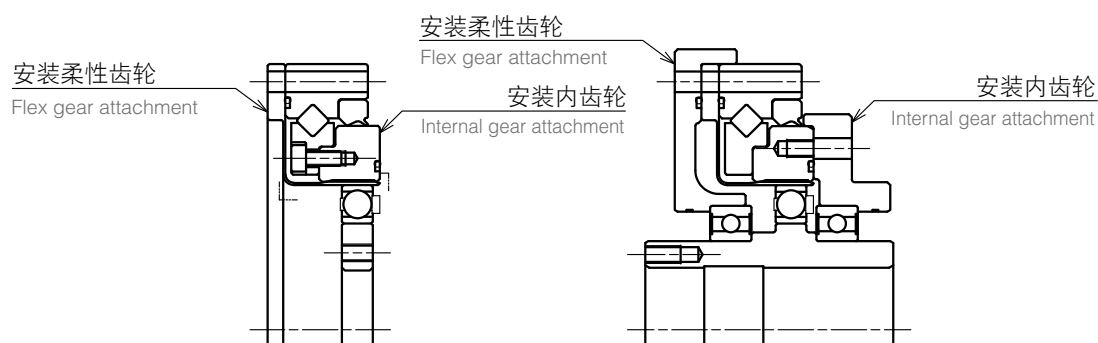

注意事项 *Installation and assembly instructions*

输入/ 输出轴的支撑 (WPC-□-□-□)

Shaft installation instruction

输入轴/ 输出轴请采用承受作用于轴部的径向负荷/ 轴向负荷的支撑构造。(下图为参考实例)
来自减速机内部的轴向负荷作用于凸轮。请进行固定，避免凸轮发生轴向移动。

Please design the support structure for input shaft and output shaft so that both radial and axial loads are supported. (Diagram below shows an example)

Inside thrust load has effect on the cam. Secure cam from the possible axial movement.

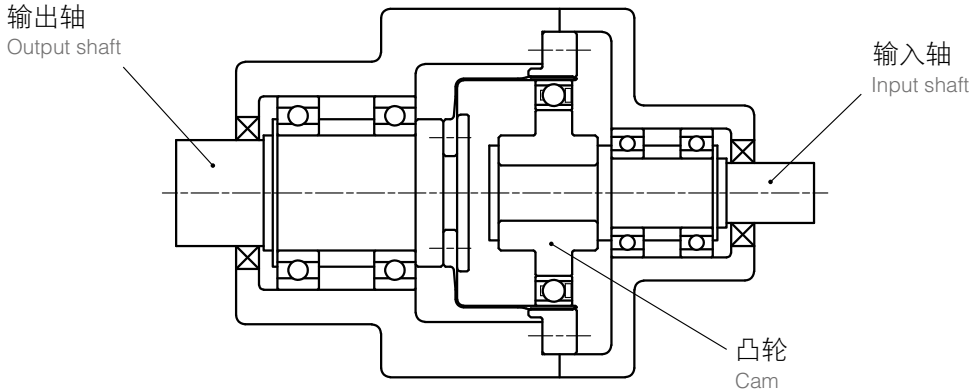

规格
Reducer Model /
Specifications

尺寸表
Dimensions Table

寿命计算 (薄壁轴承) /
寿命计算 (主轴承)
Life estimation
(Elastic bearing) /
Life estimation (Main bearing)

输入轴容许负荷 /
润滑油
Maximum load at
input shaft /
lubricant information

安装精度
Attachment fixture
requirement

传导力矩
Transmitting Torque

注意事项
Installation and
assembly instructions

特性数据
Characteristics Data

角度传导精度

Transmission Angular Accuracy

角度传导精度定义

在无负荷条件下使输入轴旋转时，理论上输出旋转角度与实际输出旋转角度的差值。

What is Transmission Angular Accuracy?

It is the difference between the measured output rotation angle and the theoretical angle, while input shaft is rotated with no load.

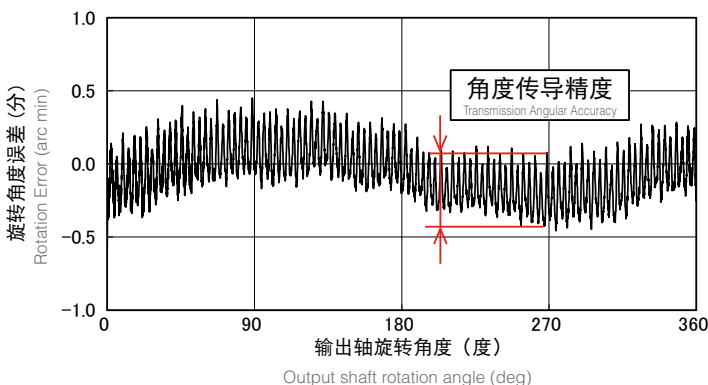

[arc min]

减速比 Ratio	尺寸 Size				
	35	42	50	63	80
50	2.0	2.0	1.5	1.0	1.0
80	1.5	1.5	1.0	1.0	1.0
100	1.5	1.5	1.0	1.0	1.0
120	-	1.5	1.0	1.0	1.0

※表中数值为参考值。

Table values are reference values.

滞后损失

Hysteresis Loss

滞后损失定义

输入侧固定后，将力矩施加至输出侧且0力矩时的扭曲角度差。

What is Hysteresis Loss?

When torque load is applied at the output shaft in alternate direction repeatedly with input shaft fixed, there is residual twisting angle when torque is back to zero.

In this context, hysteresis loss is the difference in the forward and backward twisting angle.

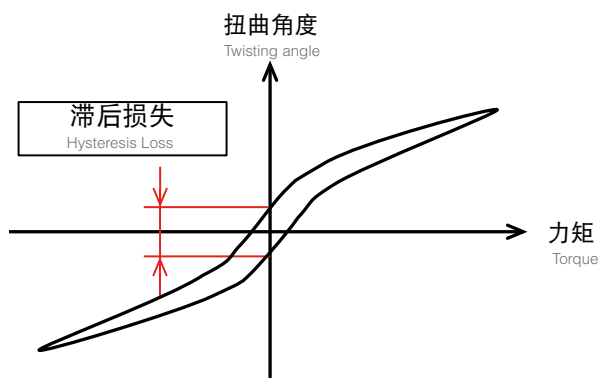

[arc min]

减速比 Ratio	尺寸 Size				
	35	42	50	63	80
50	2.0	2.0	2.0	2.0	2.0
80	1.5	1.5	1.0	1.0	1.0
100	1.5	1.5	1.0	1.0	1.0
120	-	1.5	1.0	1.0	1.0

最大背隙

Maximum Backlash

[arc sec]

最大背隙定义

输入部采用花键型组件时的输出侧松动间隙
(齿轮相咬合部位背隙为0, 所以刚构型组件背隙为0)

What is Maximum Backlash?

In this context, maximum backlash is the output backlash for spline type input shaft. (Backlash is zero for rigid type input, because gear engagement backlash is zero.)

刚性 (封闭型、组合型)

Stiffness (Closed type, Unit)

刚性定义

固定输入侧, 将力矩施加至输出侧时的弹簧常数与扭曲角度

What is Stiffness?

In this context, stiffness is the output shaft twisting angle and the spring coefficient, while torque load is applied to the output shaft with input side fixed.

减速比 Ratio	尺寸 Size				
	35	42	50	63	80
50	27	27	18	16	16
80	17	17	11	10	10
100	13	13	9	8	8
120	-	11	7	7	7

K1...力矩 0 ~ T₁ 的弹簧常数

Spring coefficient at 0 ~ T₁ torque

K2...力矩 T₁ ~ T₂ 的弹簧常数

Spring coefficient at T₁ ~ T₂ torque

K3...力矩 T₂ ~ 的弹簧常数

Spring coefficient at T₂ ~ torque

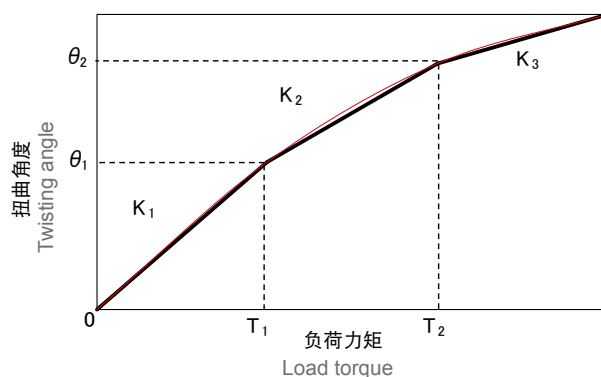

减速比 Ratio	符号 item	单位 unit	尺寸 Size				
			35	42	50	63	80
-	T ₁	Nm	2	3.9	7	14	29
-	T ₂	Nm	6.9	12	25	48	108
50	K ₁	× 10 ⁴ Nm/rad	0.39	0.66	1.1	2.2	4.6
	K ₂	× 10 ⁴ Nm/rad	0.47	0.75	1.4	2.6	5.1
	K ₃	× 10 ⁴ Nm/rad	0.52	0.82	1.4	2.7	5.6
	θ ₁	arcmin	1.7	2.0	2.2	2.2	2.2
	θ ₂	arcmin	5.0	5.5	6.3	6.4	7.2
80	K ₁	× 10 ⁴ Nm/rad	0.44	0.86	1.6	2.9	6.2
	K ₂	× 10 ⁴ Nm/rad	0.60	1.0	1.9	3.2	6.5
	K ₃	× 10 ⁴ Nm/rad	0.72	1.0	1.9	3.1	6.5
	θ ₁	arcmin	1.6	1.6	1.5	1.7	1.6
	θ ₂	arcmin	4.0	4.1	4.6	5.2	5.7

※表中数值为平均值。
Average value shown in the table

规格
Reducer Model / Specifications

尺寸表
Dimensions Table

寿命计算 (薄壁轴承) / 寿命计算 (主轴) / Life estimation (Elastic bearing) / Life estimation (Main bearing)

输入轴容许负荷 / 润滑油 / Maximum load at input shaft / Lubricant information

安装精度
Attachment fixture requirement

传导力矩
Transmitting Torque

注意事项
Installation and assembly instructions

特性数据
Characteristics Data

启动力矩 (封闭型、组合型)

[cNm]

Starting Torque (Closed type, Unit)

启动力矩定义

由输入侧使其旋转时，输入侧开始旋转的力矩。

(无负荷，环境温度：25℃)

What is Starting Torque?

Input torque needed for input side to start rotating (no load, ambient temperature : 25℃)

减速比 Ratio	尺寸 Size				
	35	42	50	63	80
50	7.0	11	14	17	26
80	6.8	9.5	13	24	26
100	6.4	9.4	11	14	20
120	-	8.1	9.3	14	20

※1 根据使用条件不同，数值存在差异，所以上表作为参考值使用。

※2 不包括输入侧油封及球形轴承等的旋转阻力所带来的影响。

*1 For reference only. Torque value may vary depending on the condition.

*2 Charts does not show effects due to rotation resistance of bearings and oil seals on the input side.

加速启动力矩

(封闭型、组合型)

Output Starting Torque(Closed type, Unit)

加速启动力矩定义

由输出侧使其旋转时，输出侧开始旋转的力矩。

(无负荷，环境温度：25℃)

What is Output Starting Torque?

Output torque needed for output side to start rotating (no load, ambient temperature : 25℃)

减速比 Ratio	尺寸 Size				
	35	42	50	63	80
50	1.2	3.6	4.4	5.8	13
80	1.6	3.9	7.2	13	26
100	1.7	5.7	8.6	9.4	23
120	-	4.2	8.1	10	30

※1 根据使用条件不同，数值存在差异，所以上表作为参考值使用。

※2 不包括输入侧油封及球形轴承等的旋转阻力所带来的影响。

*1 For reference only. Torque value may vary depending on the condition.

*2 Charts does not show effects due to rotation resistance of bearings and oil seals on the input side.

无负荷运转力矩

(封闭型、组合型)

No-load Running Torque (Closed type, Unit)

无负荷运转力矩定义

在无负荷条件下，使其旋转所需必要的输入侧力矩。

(平均值，环境温度：25℃)

What is No-load Running Torque?

Input torque needed to keep it running with no load (average value, ambient temperature : 25℃)

减速比 Ratio	符号	尺寸 Size				
		35	42	50	63	80
50	500r/min	3.4	7.5	9.2	17	35
	1000r/min	4.3	8.2	11	18	37
	2000r/min	5.0	8.5	13	18	39
	3500r/min	5.4	11	14	22	38
80	500r/min	3.2	7.6	10	20	35
	1000r/min	4.0	8.7	12	21	38
	2000r/min	4.8	8.9	14	22	39
	3500r/min	5.2	11	14	24	38
100	500r/min	3.2	7.1	11	21	36
	1000r/min	4.0	8.2	13	23	39
	2000r/min	4.7	8.4	14	24	39
	3500r/min	5.1	9.7	14	25	38
120	500r/min	-	6.7	9.8	23	40
	1000r/min	-	8.1	12	24	41
	2000r/min	-	8.4	13	26	41
	3500r/min	-	8.4	13	26	39

※1 根据使用条件不同，数值存在差异，所以上表作为参考值使用。

※2 不包括输入侧油封及球形轴承等的旋转阻力所带来的影响。

*1 For reference only. Torque value may vary depending on the condition.

*2 Charts does not show effects due to rotation resistance of bearings and oil seals on the input side.

效率 (封闭型、组合型)

Efficiency (Closed type, Unit)

负荷[%] : 负荷力矩/容许平均力矩
环境温度 : 25°C

※1 图表为实测数据的平均值。

※2 不包括输入侧油封及球形轴承等的旋转阻力所带来的影响。

·Percentile Load (%) is equal to load torque divided by allowable average torque.

·Ambient temperature : 25°C

*1 These diagrams represent the average value of the actual measurement.

*2 Charts does not show effects due to rotation resistance of bearings and oil seals on the input side.

WPU-35-50

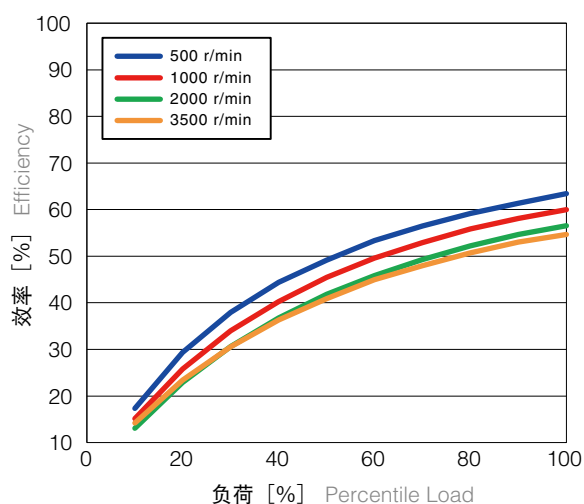

WPU-35-80

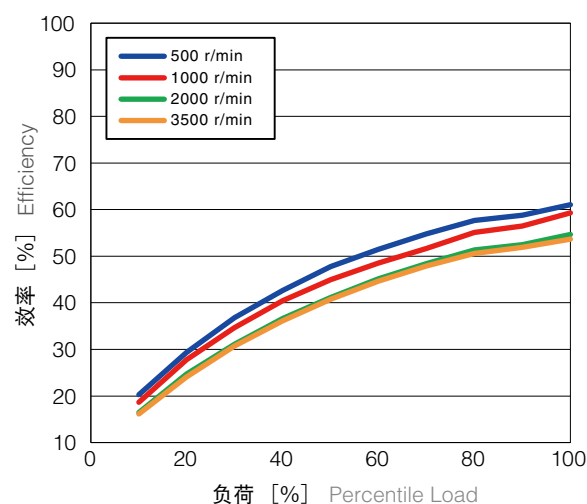

WPU-35-100

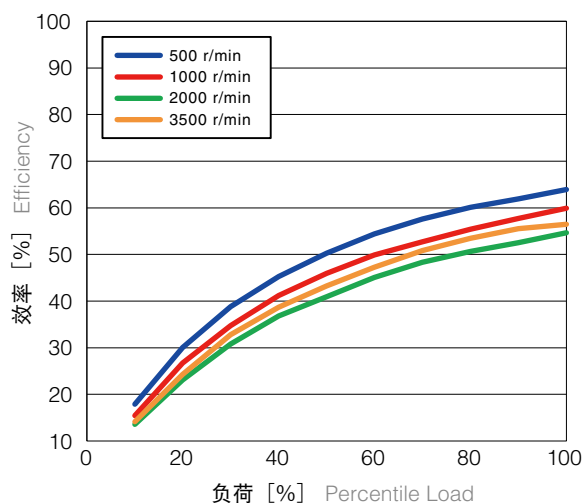

特性数据 Characteristics Data

效率 (封闭型、组合型)

Efficiency (Closed type, Unit)

负荷[%] : 负荷力矩/容许平均力矩

环境温度: 25°C

※1 图表为实测数据的平均值。

※2 不包括输入侧油封及球形轴承等的旋转阻力所带来的影响。

·Percentile Load (%) is equal to load torque divided by allowable average torque.

·Ambient temperature : 25°C

*1 These diagrams represent the average value of the actual measurement.

*2 Charts does not show effects due to rotation resistance of bearings and oil seals on the input side.

WPU-42-50

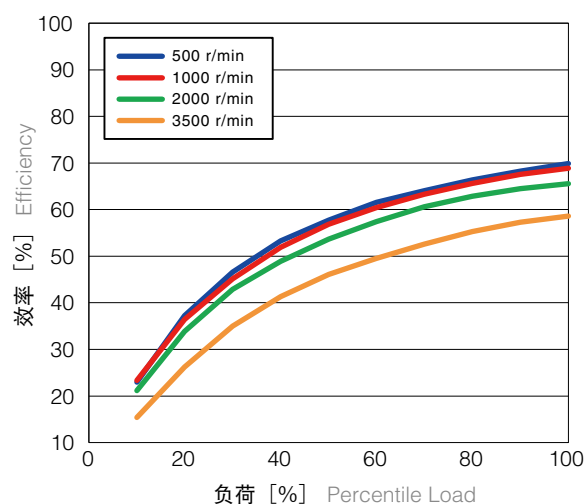

WPU-42-80

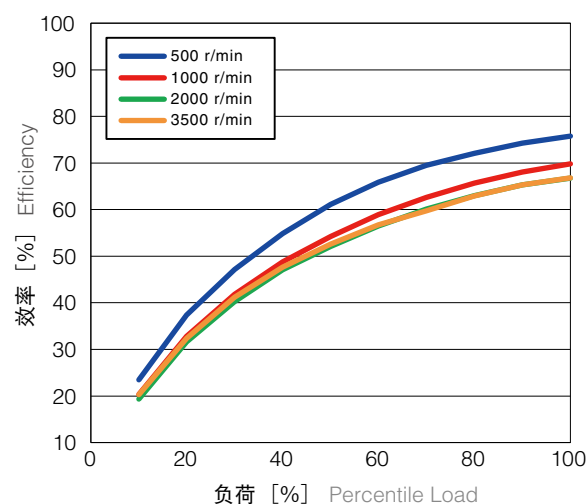

WPU-42-100

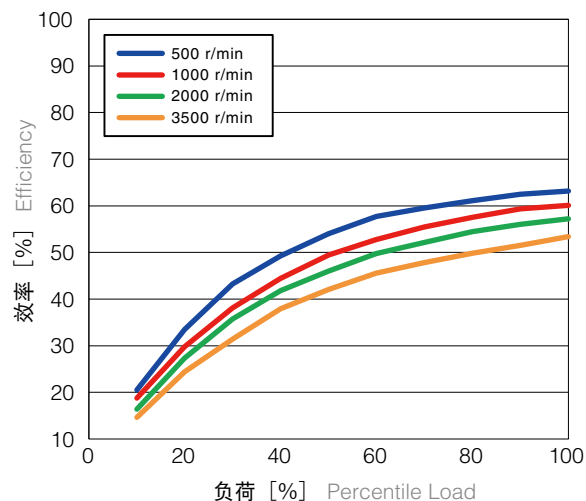

WPU-42-120

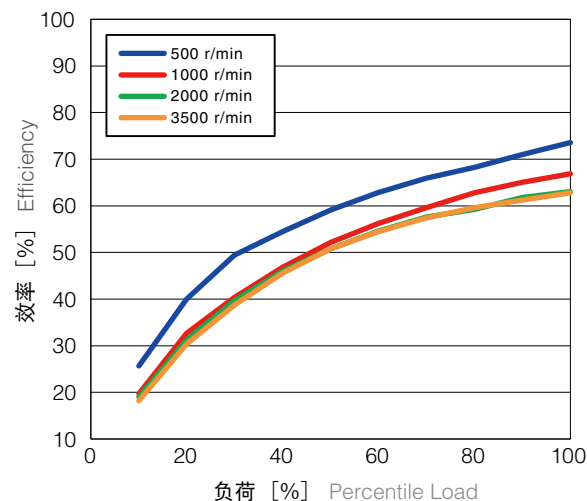

效率 (封闭型、组合型)

Efficiency (Closed type, Unit)

负荷[%] : 负荷力矩/容许平均力矩
环境温度 : 25°C

※1 图表为实测数据的平均值。

※2 不包括输入侧油封及球形轴承等的旋转阻力所带来的影响。

·Percentile Load (%) is equal to load torque divided by allowable average torque.

·Ambient temperature : 25°C

*1 These diagrams represent the average value of the actual measurement.

*2 Charts does not show effects due to rotation resistance of bearings and oil seals on the input side.

WPU-50-50

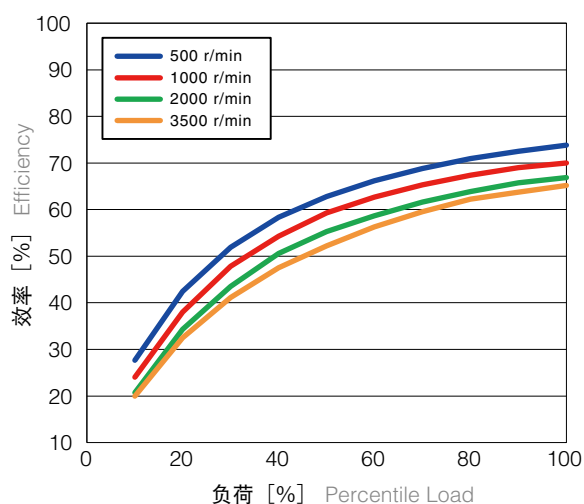

WPU-50-80

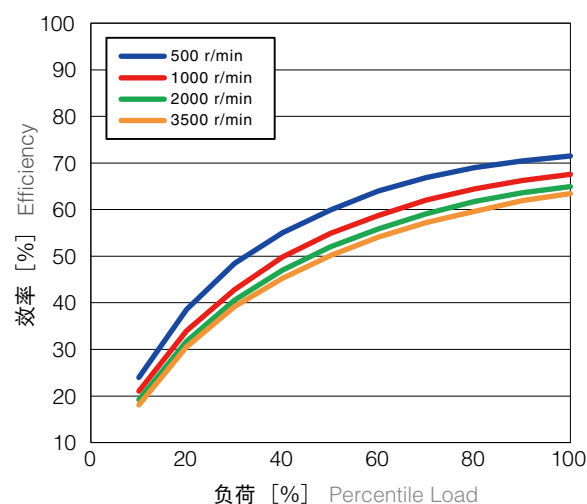

WPU-50-100

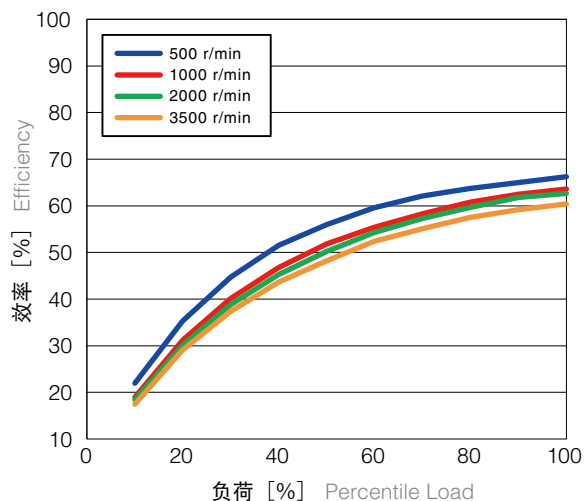

WPU-50-120

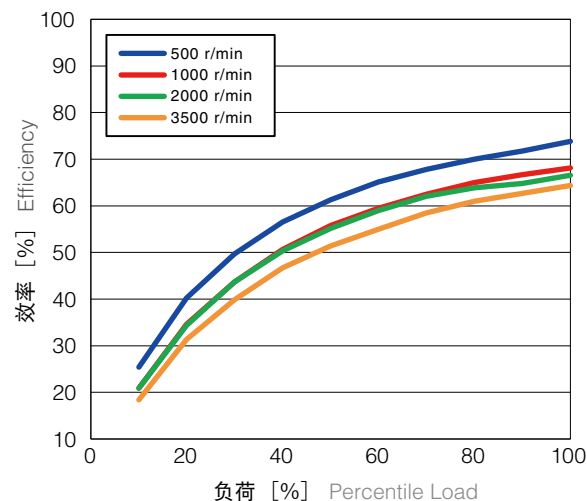

特性数据 *Characteristics Data*

效率 (封闭型、组合型)

Efficiency (Closed type, Unit)

负荷[%] : 负荷力矩/容许平均力矩

环境温度 : 25°C

※1 图表为实测数据的平均值。

※2 不包括输入侧油封及球形轴承等的旋转阻力所带来的影响。

·Percentile Load (%) is equal to load torque divided by allowable average torque.

·Ambient temperature : 25°C

*1 These diagrams represent the average value of the actual measurement.

*2 Charts does not show effects due to rotation resistance of bearings and oil seals on the input side.

WPU-63-50

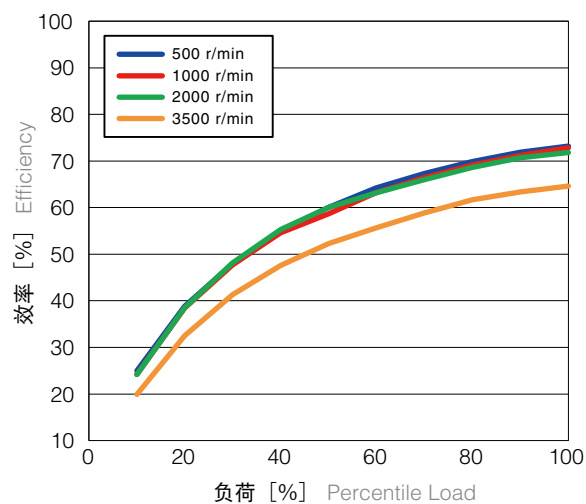

WPU-63-80

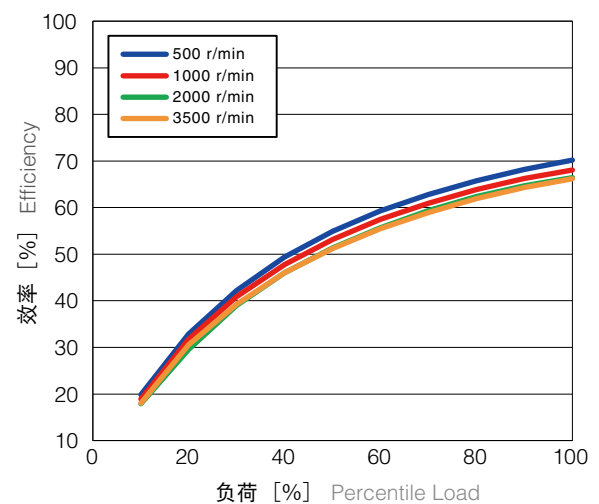

WPU-63-100

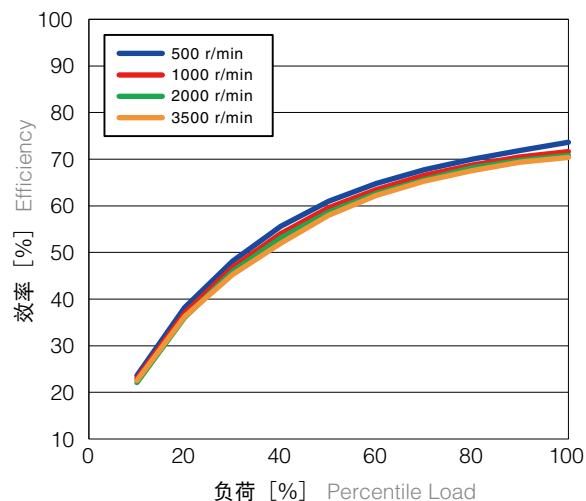

WPU-63-120

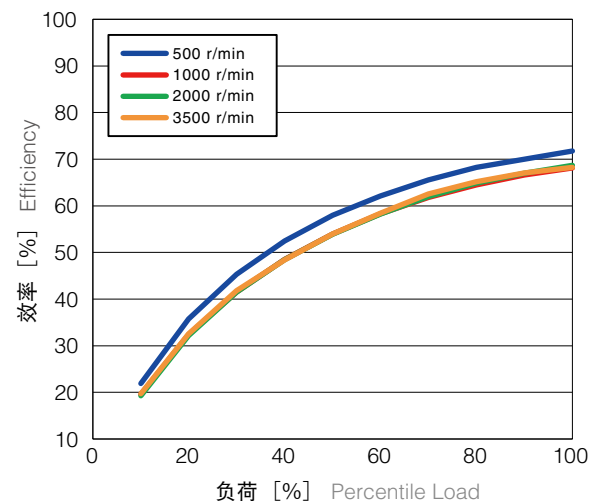

效率 (封闭型、组合型)

Efficiency (Closed type, Unit)

负荷[%] : 负荷力矩/容许平均力矩

环境温度 : 25°C

※1 图表为实测数据的平均值。

※2 不包括输入侧油封及球形轴承等的旋转阻力所带来的影响。

·Percentile Load (%) is equal to load torque divided by allowable average torque.

·Ambient temperature : 25°C

*1 These diagrams represent the average value of the actual measurement.

*2 Charts does not show effects due to rotation resistance of bearings and oil seals on the input side.

WPU-80-50

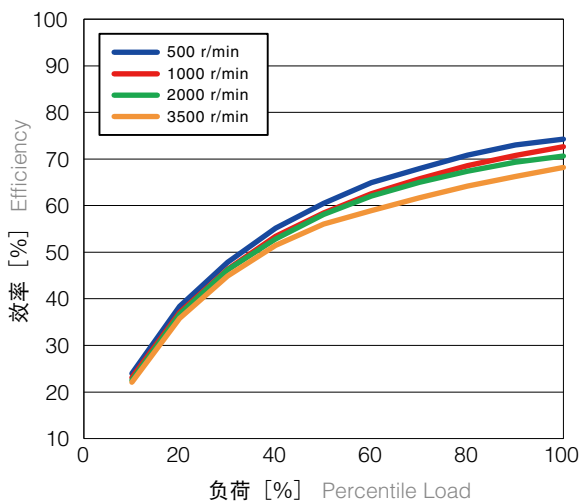

WPU-80-80

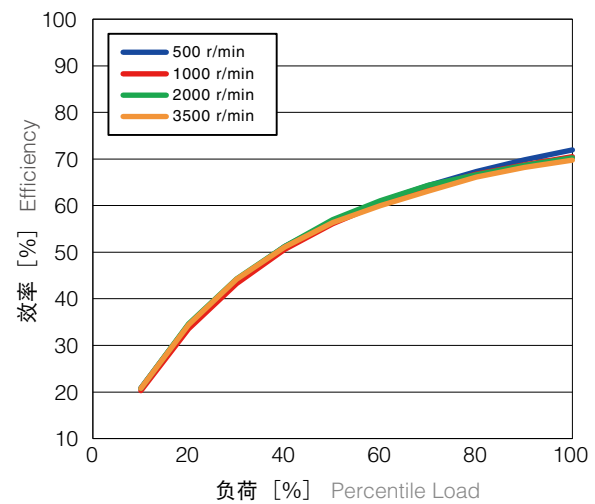

WPU-80-100

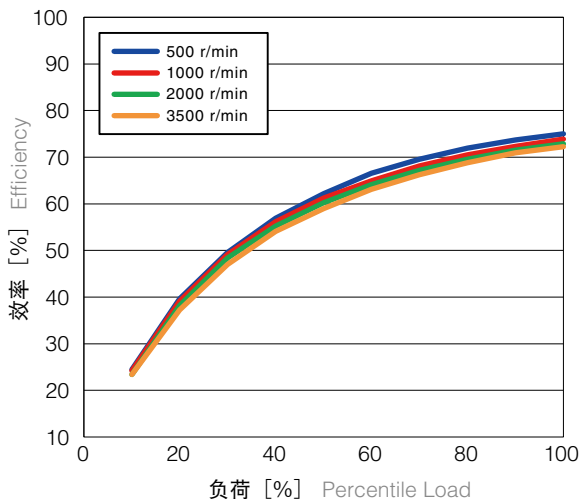

WPU-80-120

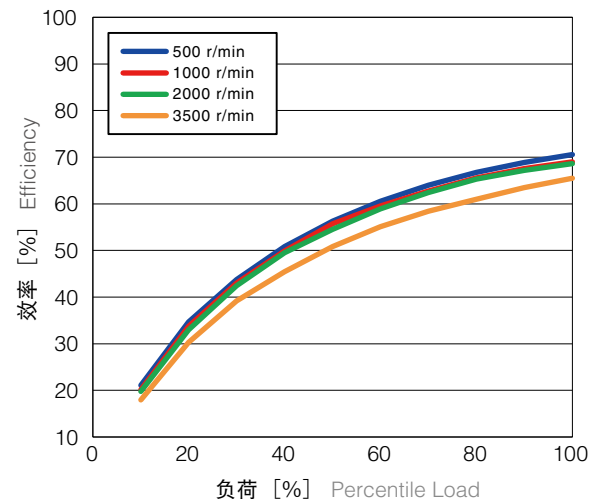

Nidec

尼得科

— All for dreams

日本电产新宝(浙江)有限公司

NIDEC-SHIMPO (ZHEJIANG) CORPORATION

地址：平湖经济开发区平成路1858号

电话号码：0573-8507-9561 (代表)

传真号码：0573-8509-3543 邮编：314200

<http://www.nidec-shimpo.co.jp/>