

MOSFET

200 Amps,40 Volts N-CHANNEL MOSFET

FEATURE

- ◆ Low gate charge
- ◆ Low Ciss
- ◆ Fast switching
- ◆ 100% avalanche tested
- ◆ Improved dv/dt capability
- ◆ RoHS 2.0 Compliant

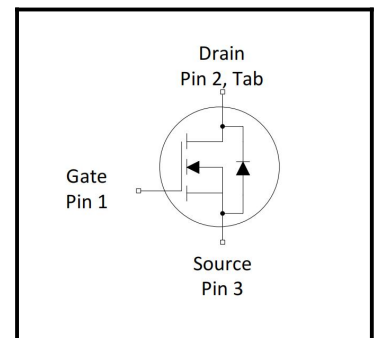
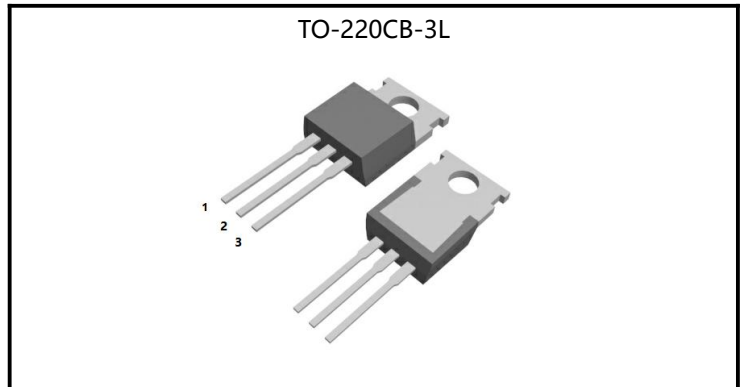

Parameter	Values	Unit
Bvdss	40	V
Id	200	A
Rdson(max)	3	mΩ

Ordering Code	Marking	Package	Packaging
PW030N04C	PW030N04C	TO-220CB-3L	Tube

Absolute Maximum Ratings($T_C=25^{\circ}\text{C}$, unless otherwise noted)

Parameter	Symbol	Values			Unit	Note/Test Conditions
		Min	Typ	Max		
Drain-Source Voltage	V_{DSS}	-	-	40	V	-
Gate-Source Voltage	V_{GS}	-20	-	20	V	-
Continuous Drain Current(Package Limited)	I_D	-	-	200	A	$T_C=25^{\circ}\text{C}$
		-	-	160	A	$T_C=100^{\circ}\text{C}$
Pulsed Drain Current(Note1)	I_{DM}	-	-	800	A	-
Single Pulse Avalanche Energy	E_{AS}	-	-	1200	mJ	$L=0.5\text{mH}, V_D=32\text{V}, T_C=25^{\circ}\text{C}$
Maximum Power Dissipation	P_D	-	-	250	W	$T_C=25^{\circ}\text{C}$
Reverse Diode dV/dt (Note2)	dv/dt	-	-	5	V/ns	-
Operating Junction and Storage Temperature Range	T_J, T_{STG}	-55	-	150	$^{\circ}\text{C}$	-
Maximum lead temperature for soldering purposes, 1/8" from case for 5 seconds	T_L	-	-	260	$^{\circ}\text{C}$	-

Thermal Characteristics

Parameter	Symbol	Values			Unit	Note/Test Conditions
		Min	Typ	Max		
Thermal resistance , Channel to Case	$R_{th(ch-c)}$	-	0.5	-	$^{\circ}\text{C}/\text{W}$	-
Thermal resistance , Channel to Ambient	$R_{th(ch-a)}$	-	62	-		-

Electrical Characteristics ($T_C=25^{\circ}\text{C}$, unless otherwise noted)

Static characteristics

Parameter	Symbol	Values			Unit	Note/Test Conditions
		Min	Typ	Max		
Drain-Source Breakdown Voltage	BV_{DSS}	40	-	-	V	$V_{GS}=0\text{V}, I_D=250\mu\text{A}$
Zero Gate Voltage Drain Current	I_{DSS}	-	-	1.0	μA	$V_{DS}=40\text{V}, V_{GS}=0\text{V}$
Gate-Body Leakage Current, Forward	I_{GSSF}	-	-	100	nA	$V_{GS}=20\text{V}, V_{DS}=0\text{V}$
Gate-Body Leakage Current, Reverse	I_{GSSR}	-	-	-100	nA	$V_{GS}=-20\text{V}, V_{DS}=0\text{V}$
Gate-Source Threshold Voltage	$V_{GS(th)}$	2.0	-	4.0	V	$V_{DS}=V_{GS}, I_D=250\mu\text{A}$
Drain-Source On-State Resistance	$R_{DS(on)}$	-	2.2	3	$\text{m}\Omega$	$V_{GS}=10\text{V}, I_D=20\text{A}$
Gate Resistance	R_g	-	2.1	-	Ω	$V_{GS}=0\text{V}, V_{DS}$ Open, $f=1\text{MHz}$
Forward Transconductance	g_{fs}	-	221	-	S	$V_{DS}=10\text{V}, I_D=20\text{A}$

Dynamic characteristics

Parameter	Symbol	Values			Unit	Note/Test Conditions
		Min	Typ	Max		
Input Capacitance	C_{iss}	-	4840	-	pF	$V_{DS}=25V, V_{GS}=0V, f=1.0MHz$
Output Capacitance	C_{oss}	-	680	-	pF	$V_{DS}=25V, V_{GS}=0V, f=1.0MHz$
Reverse Transfer Capacitance	C_{rss}	-	430	-	pF	$V_{DS}=25V, V_{GS}=0V, f=1.0MHz$
Turn-On Delay Time	$t_{d(on)}$	-	21	-	ns	$V_{DD}=20V, R_G=2.5\Omega, V_{GS}=10V, I_D=20A$
Turn-On Rise Time	t_r	-	22	-	ns	$V_{DD}=20V, R_G=2.5\Omega, V_{GS}=10V, I_D=20A$
Turn-Off Delay Time	$t_{d(off)}$	-	53	-	ns	$V_{DD}=20V, R_G=2.5\Omega, V_{GS}=10V, I_D=20A$
Turn-Off Fall Time	t_f	-	21	-	ns	$V_{DD}=20V, R_G=2.5\Omega, V_{GS}=10V, I_D=20A$

Gate charge characteristics

Parameter	Symbol	Values			Unit	Note/Test Conditions
		Min	Typ	Max		
Total Gate Charge	Q_g	-	95	-	nC	$V_{DS}=20V, I_D=20A, V_{GS}=10V$
Gate-Source Charge	Q_{gs}	-	27	-	nC	$V_{DS}=20V, I_D=20A, V_{GS}=10V$
Gate-Drain Charge	Q_{gd}	-	28	-	nC	$V_{DS}=20V, I_D=20A, V_{GS}=10V$

Reverse diode

Parameter	Symbol	Values			Unit	Note/Test Conditions
		Min	Typ	Max		
Continuous Diode Forward Current	I_S	-	-	200	A	-
Pulsed Diode Forward Current	I_{SM}	-	-	800	A	-
Diode Forward Voltage	V_{SD}	-	0.90	1.2	V	$I_S=20A, V_{GS}=0V$
Reverse Recovery Time	t_{rr}	-	46	-	ns	$V_{GS}=0V, I_F=20A$
Reverse Recovery Charge	Q_{rr}	-	19	-	nC	$di/dt=100A/\mu s, (Note2)$

Notes

1. Repetitive Rating:pulse width limited by maximum junction temperature.
2. Pulse width $\leq 300\mu s$,duty cycle $\leq 2\%$.

RATING AND CHARACTERISTIC CURVES

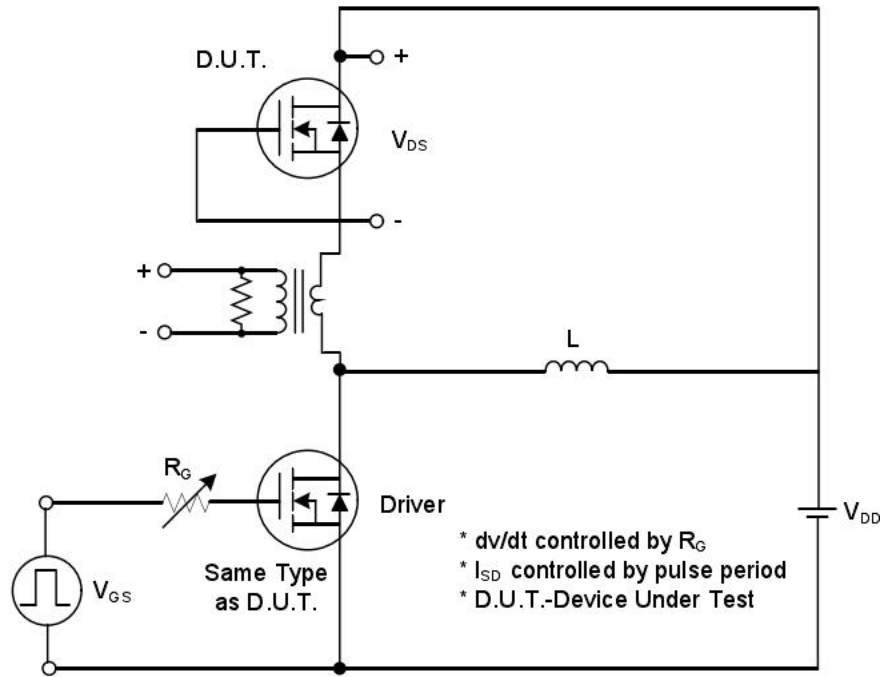

Peak Diode Recovery dv/dt Test Circuit

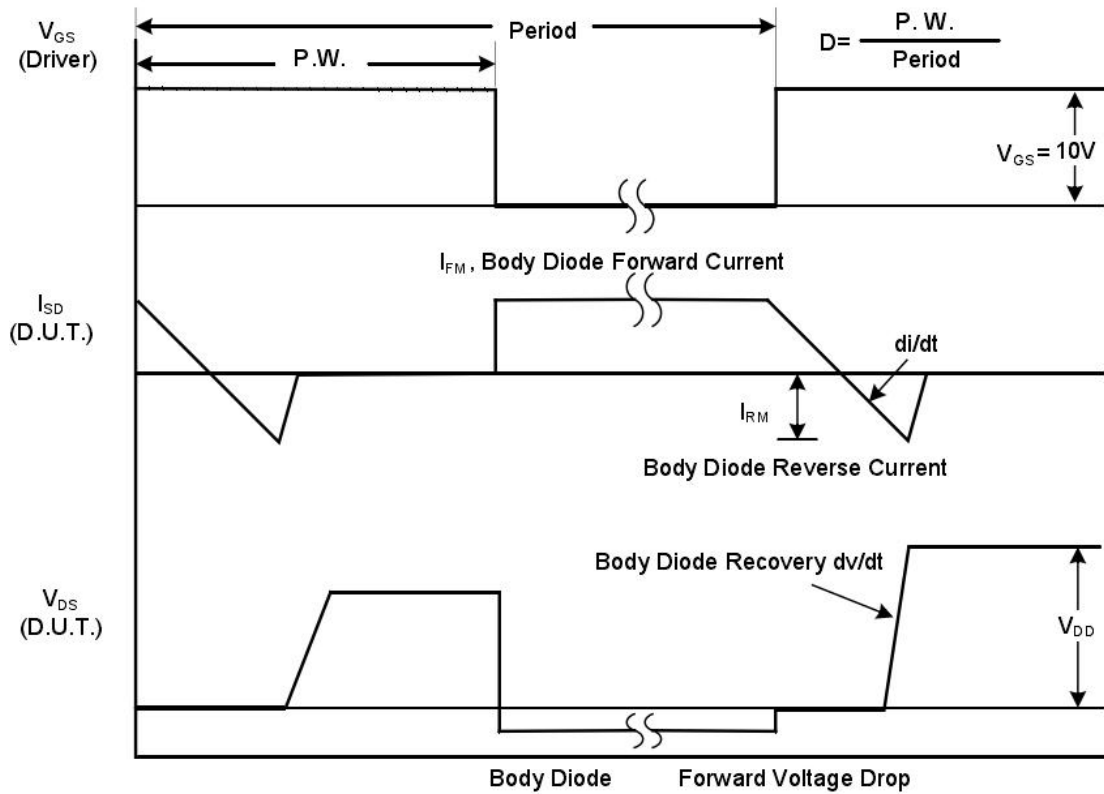

Peak Diode Recovery dv/dt Waveforms

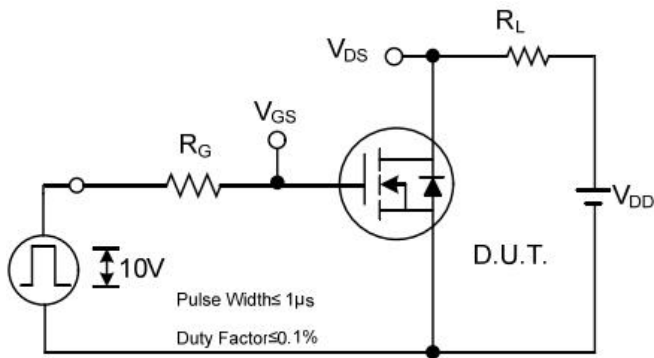

Switching Test Circuit

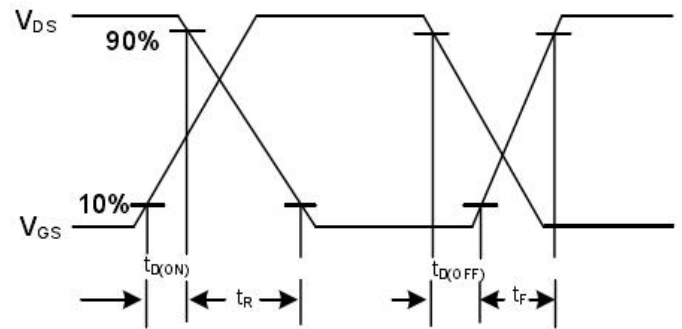

Switching Waveforms

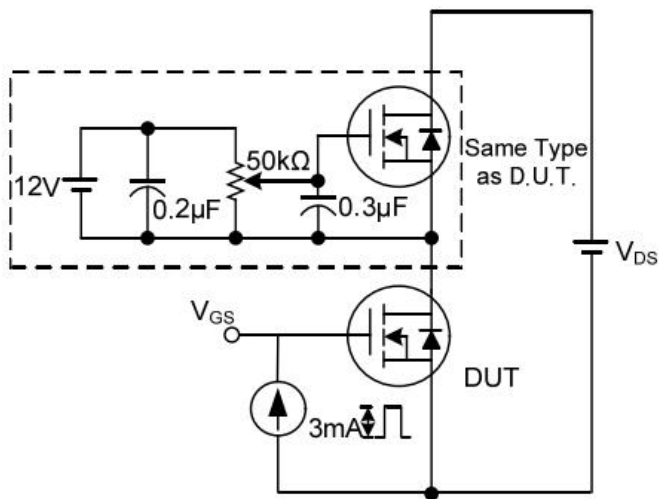

Gate Charge Test Circuit

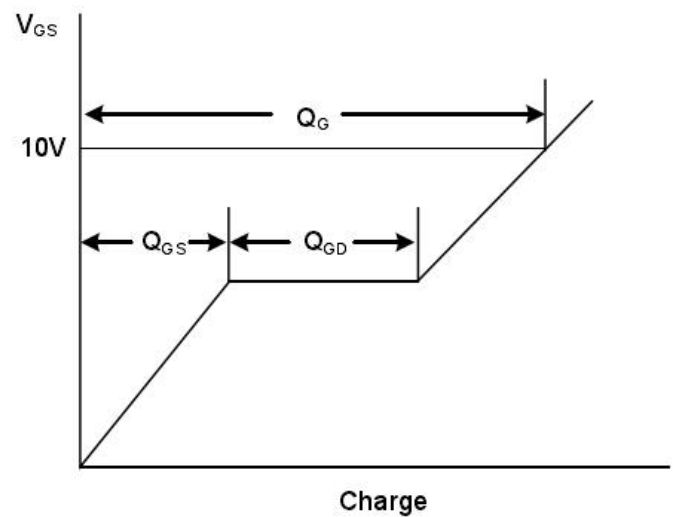

Gate Charge Waveform

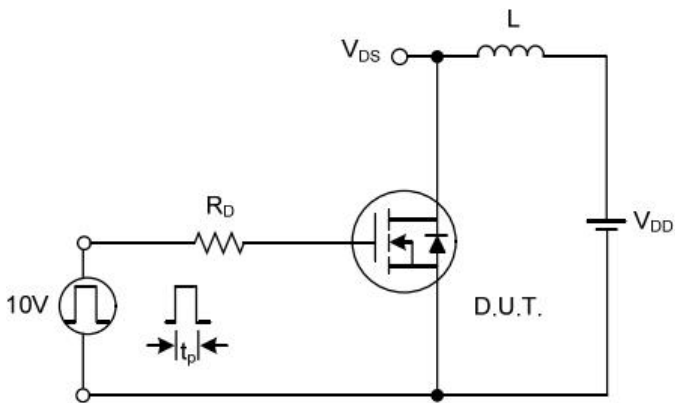

Unclamped Inductive Switching Test Circuit

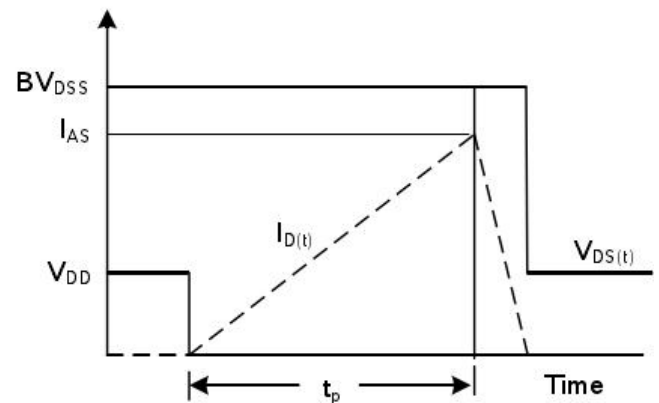

Unclamped Inductive Switching Waveforms



RATING AND CHARACTERISTIC CURVES

Figure.1 Typical Output Characteristics

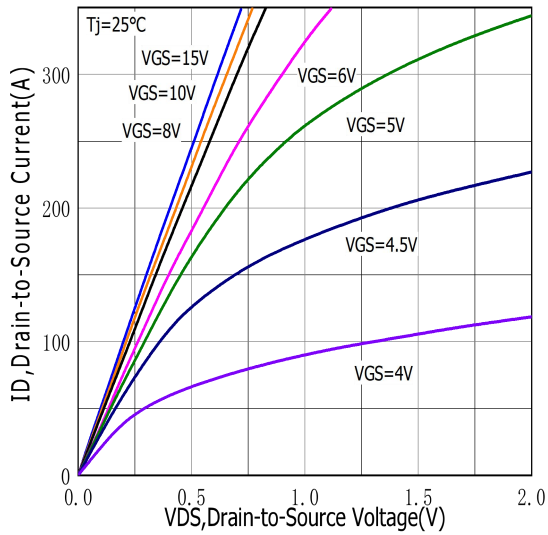

Figure.2 Typical Gate Charge vs Gate to Source Voltage

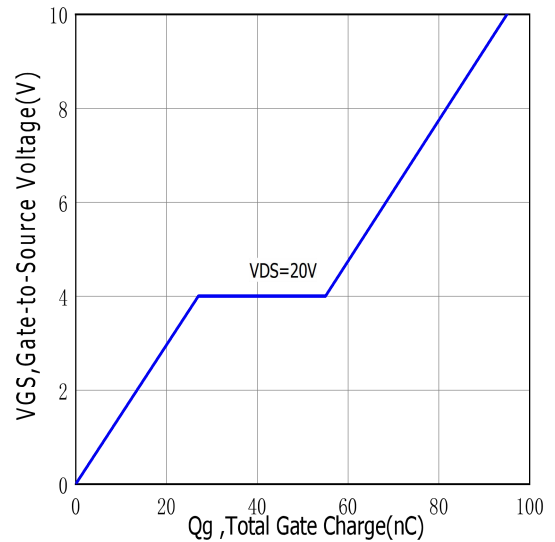

Figure.3 Typical Body Diode Transfer Characteristics

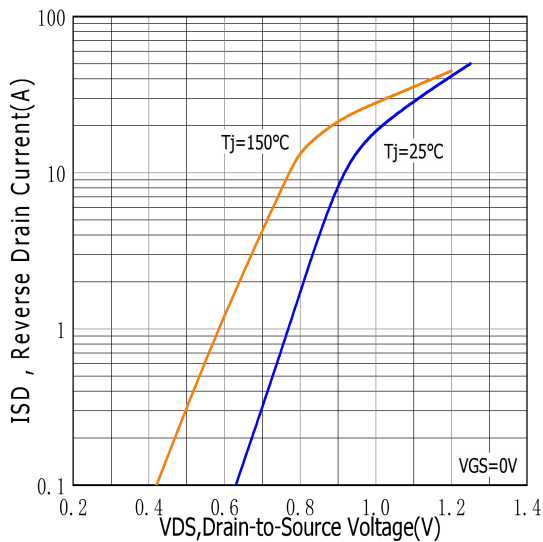
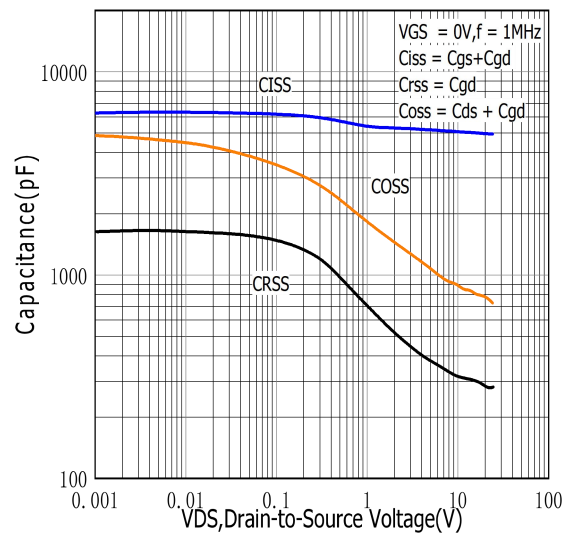
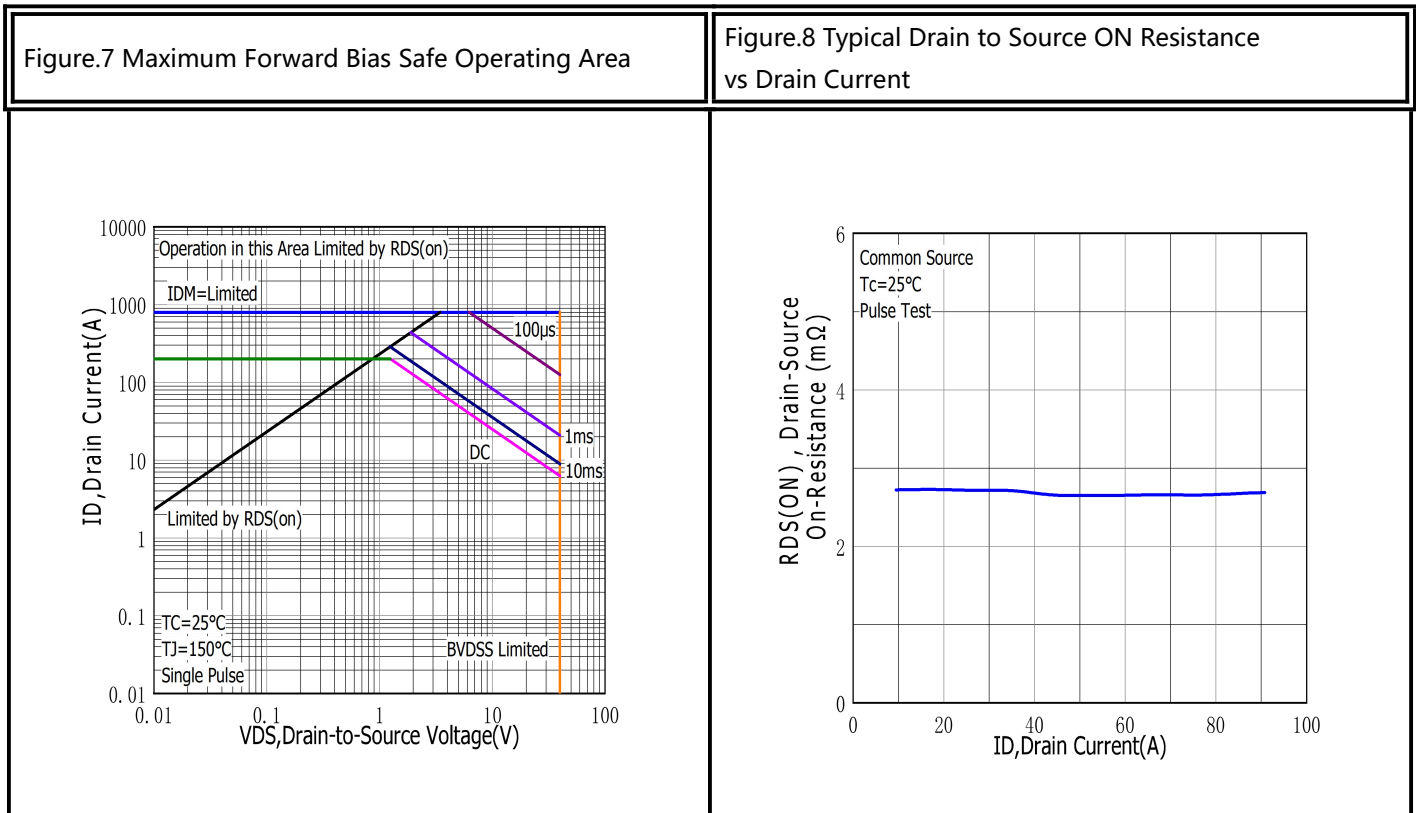
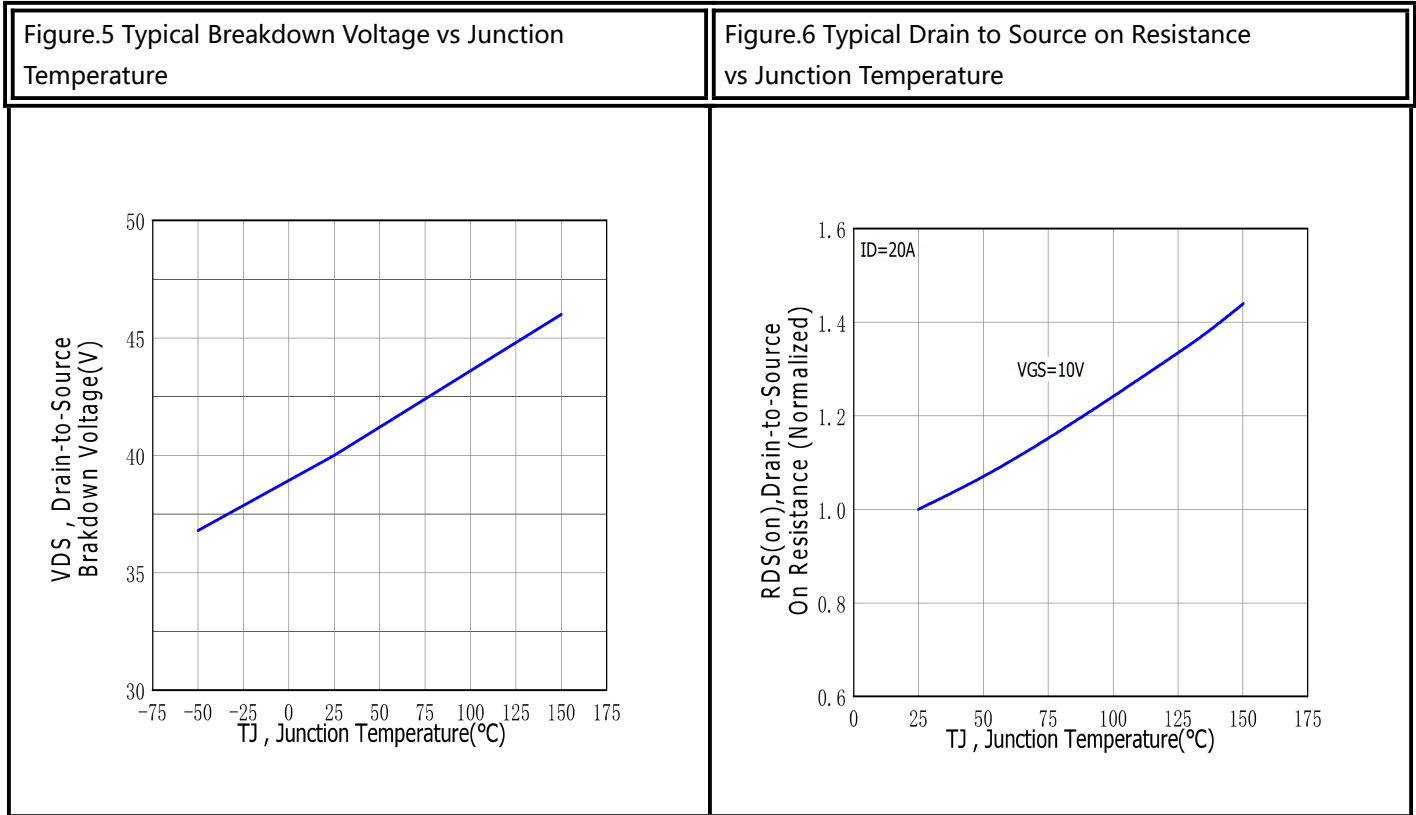

Figure.4 Typical Capacitance vs Drain to Source Voltage





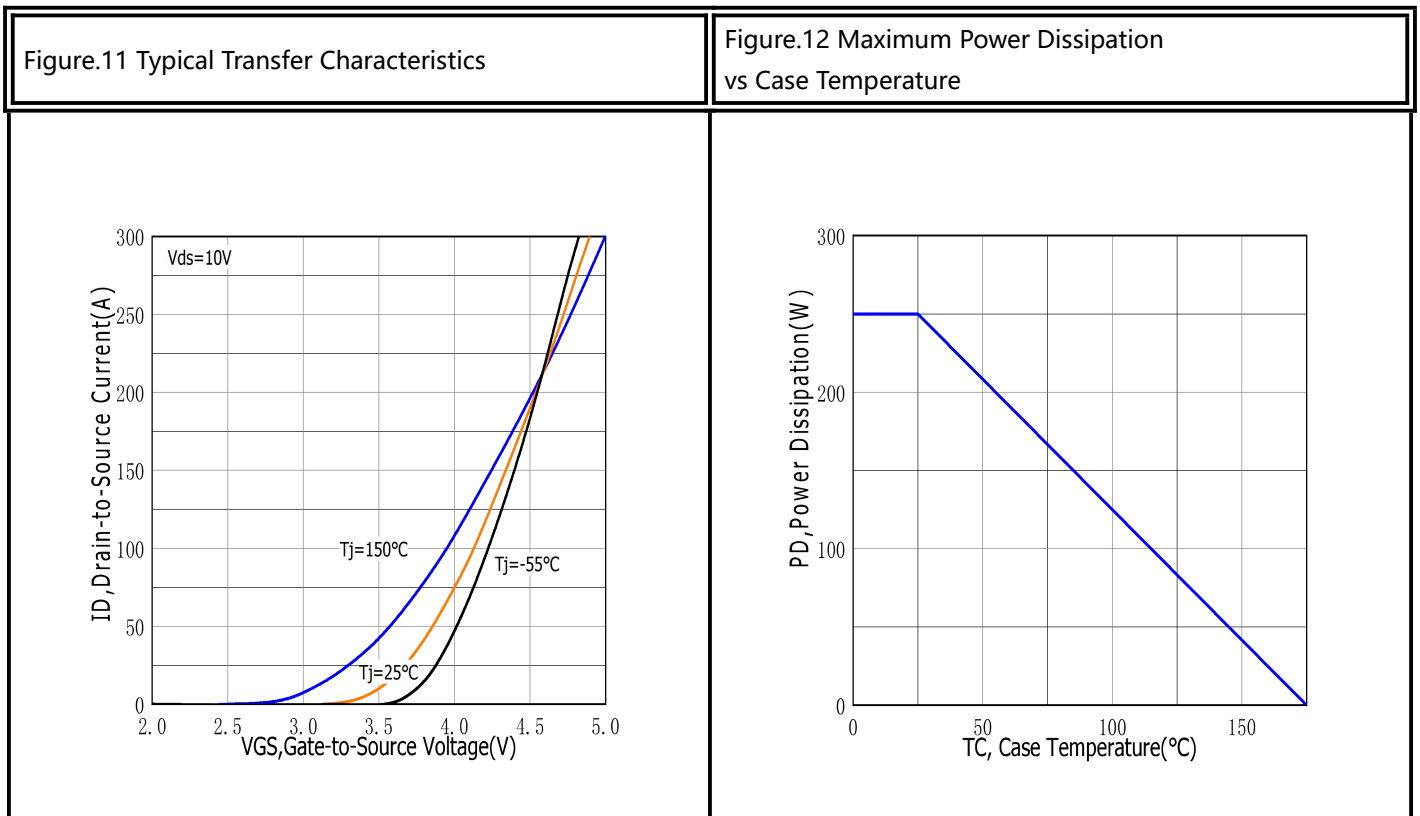
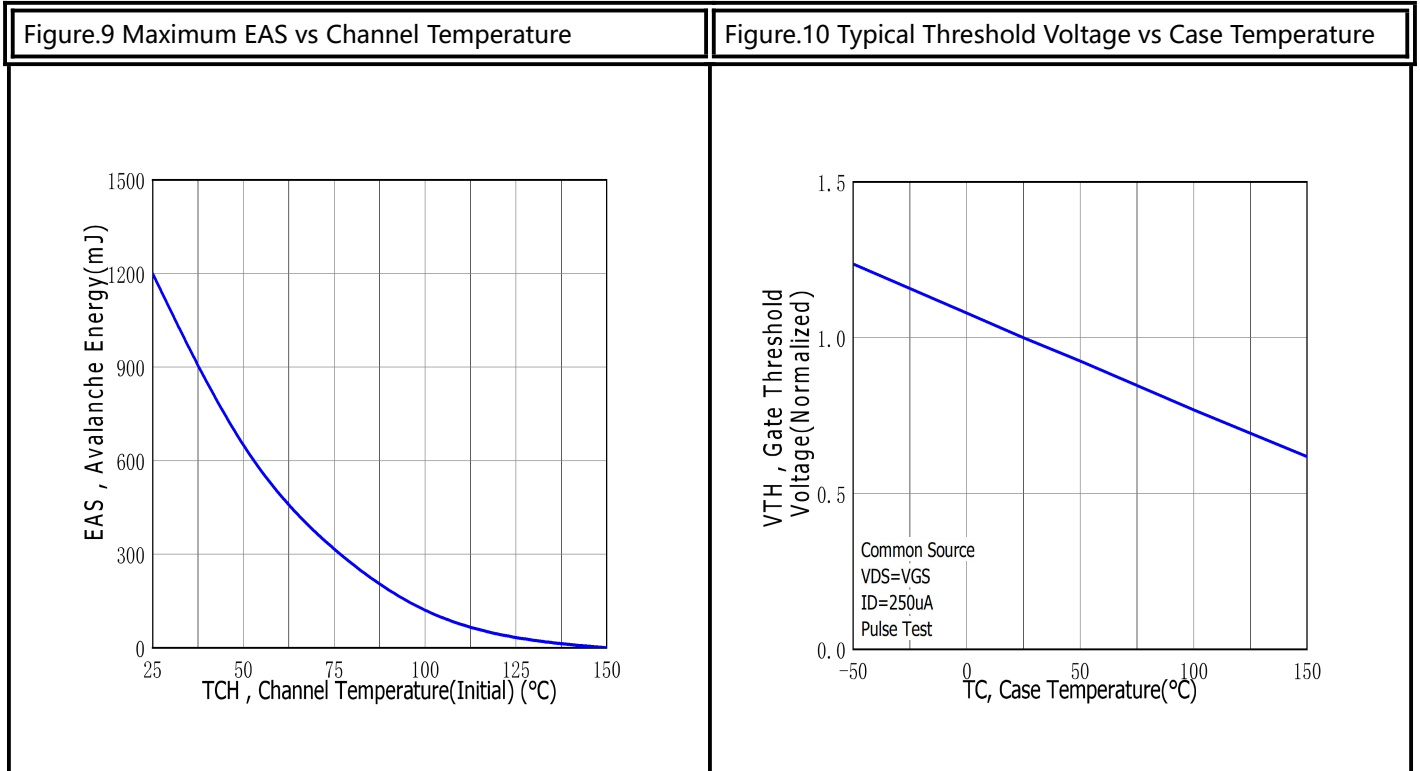
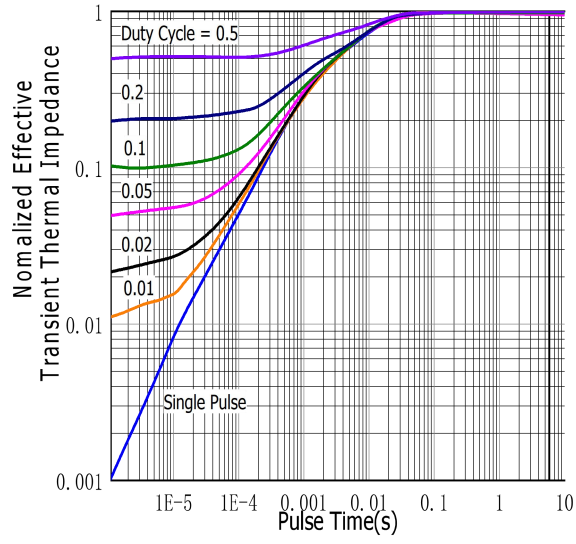
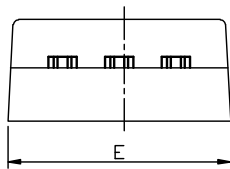
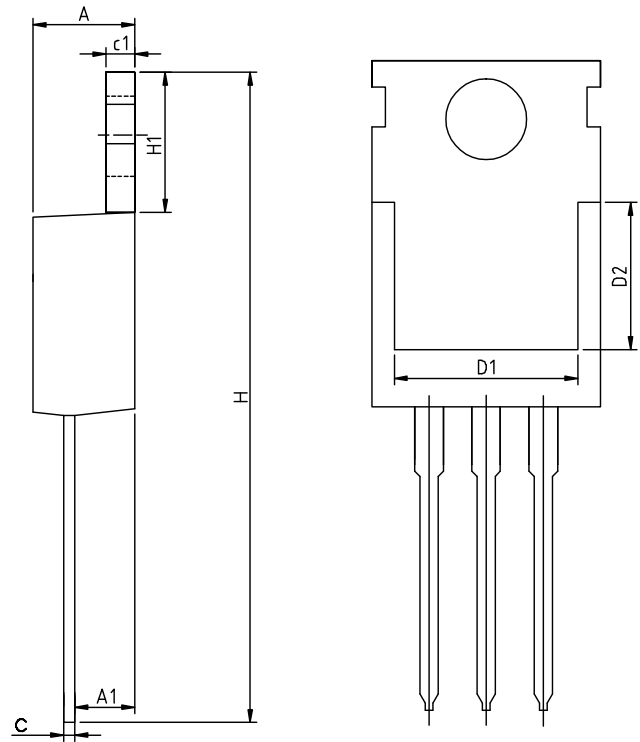
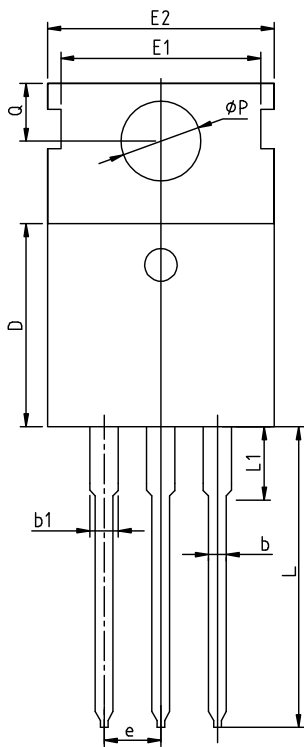



Figure.13 Maximum Effective Thermal Impedance , Junction to Case



TO-220CB-3L PACKAGE OUTLINE



RECOMMENDED LAND PATTERN

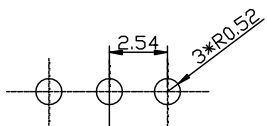

UNIT: mm

	MIN	NOM	MAX
A	4.40	4.60	4.80
A1	2.25	2.40	2.55
b	0.72	0.82	0.92
b1	1.12	1.27	1.42
c	0.40	0.50	0.60
c1	1.20	1.30	1.40
D	8.80	9.10	9.40
D1	7.75	7.95	8.15
D2	6.55	6.75	6.95
e		2.54BSC	
E	9.65	10.00	10.35
E1		8.70	
E2	9.70	10.00	10.30
H	28.70	29.20	29.70
H1	6.25	6.50	6.85
L	13.20	13.50	13.80
L1	2.80	3.10	3.40
Q	2.60	2.80	3.00
ΦP	3.45	3.60	3.75