

**Precision Regulator
G¹/₄**

- Precision instruments with integral pilot to ensure very close pressure control in a compact form
- Integral relief valve automatically vents excess outlet pressure build-up
- Unit double filters air before reaching pilot valve to help prevent leakage and malfunction
- Panel Mounting facility

Technical Data

Medium:

Compressed air only

Maximum Inlet Pressures:

10 bar standard unit

14 bar high pressure unit

8 bar low pressure unit

Operating Temperature:

0°C* to +70°C

*Consult our Technical Service for use below +2°C

Recommended Regulated Pressures^{††}:

0,07 - 4 bar standard unit

0,4 - 10 bar high pressure unit

0,02 - 0,5 bar low pressure unit

^{††}Regulated Pressure should be read from a 'Test' gauge installed on a properly designed pressure take-off Tee-piece fitted downstream of the controller.

Maximum Flow (standard unit) with 8 bar inlet pressure, 4 bar outlet pressure and pressure drop of 0,005 bar:

8 dm³/s

Maximum Flow (high pressure unit) with 10 bar inlet pressure, 8 bar outlet pressure and pressure drop of 0,01 bar:

4 dm³/s

Maximum Flow (low pressure unit) with 8 bar inlet pressure, 0,4 bar outlet pressure and pressure drop of 0,025 bar:

4 dm³/s

Note: These units are not recommended for dead-end use.

Materials

Zinc alloy body and bonnet. Acetal resin adjusting knob.

Synthetic rubber elastomeric materials.

Ordering Information

To order a standard Precision Regulator, quote model number from table overleaf.

For non-standard models substitute appropriate digits as instructed.

Port Sizes

G¹/₄ to ISO 1179

Accepts ISO 228 (BS 2779) parallel or ISO 7 (BS 21) taper connectors

Alternative Models

1/4 A.N.P.T. and other port thread forms

Maximum pressure setting stop

Slotted adjusting screw and tamper resistant cap

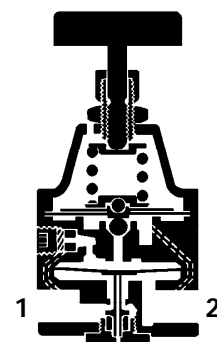
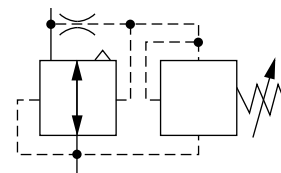



Typical Performance Characteristics

FLOW CHARACTERISTICS

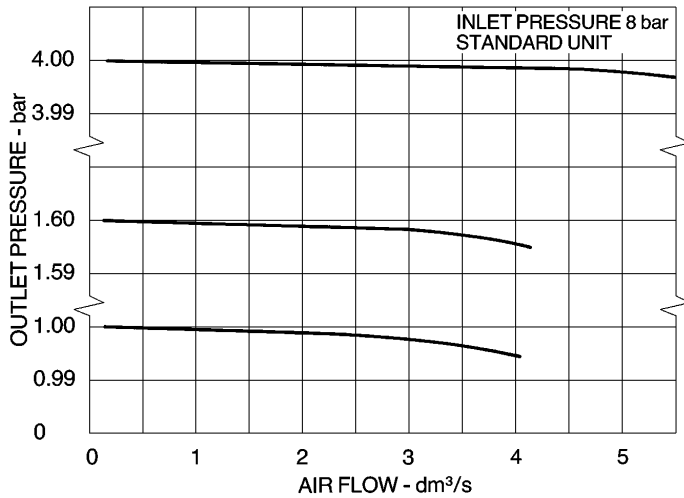

FLOW CHARACTERISTICS

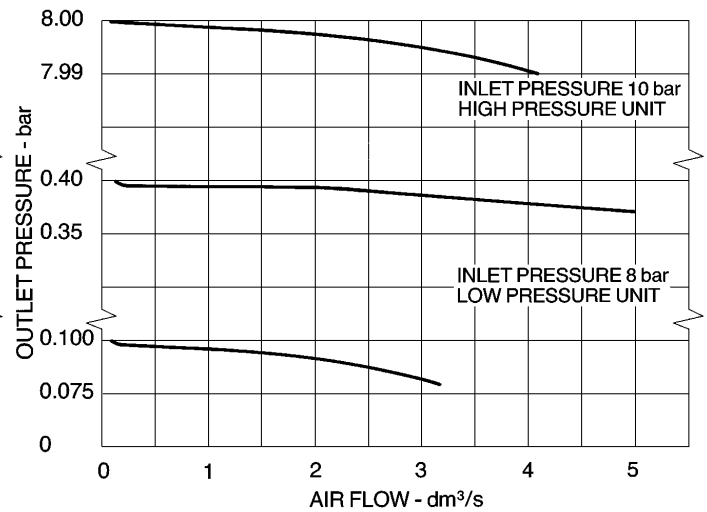

REGULATION CHARACTERISTICS

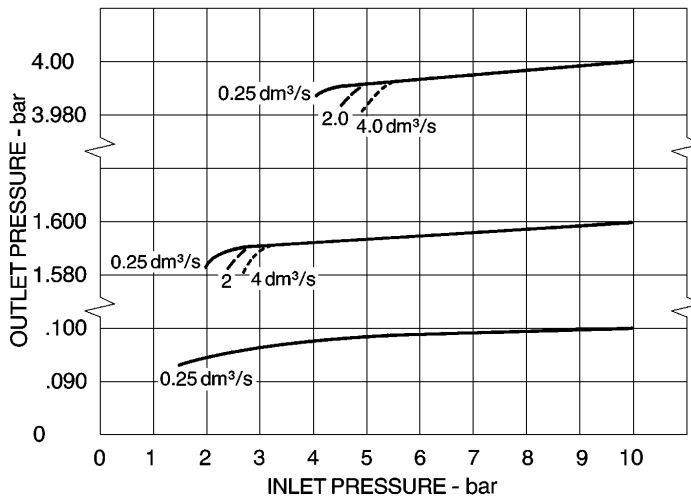

Standard Precision Regulators

Type	Spring	Port Size	Relieving	Weight kg
Standard Pressure	4 bar	G ¹ / ₄	11-818-100	0,59
High Pressure	10 bar	G ¹ / ₄	11-818-110	0,59
Low Pressure	0,5 bar	G ¹ / ₄	11-818-999	0,59

Non-standard Models

For optional 1/4 A.N.P.T. threads, substitute '0' for '8' at the 3rd digit, e.g. 11-018-100.
For other options, please consult our Technical Service.

Accessories

Alternative panel mounting nut (for panels from 2,5 mm to 6 mm), reference 3081-01.
Tamper resistant conversion kit (cap and slotted adjusting screw), reference 639-02.
Full bore connectors to 9,5 mm o.d. copper tube, reference 18-006-869 for G¹/₄ models or reference 18-006-968 for 1/4 A.N.P.T. models.



Precision Regulator

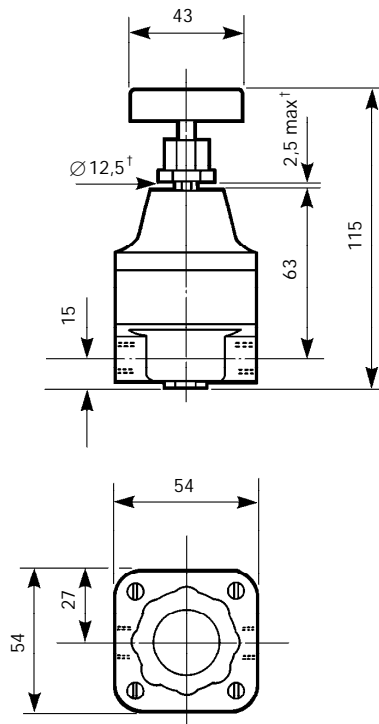

4 bar spring

Relieving

11-818-100 G¹/₄

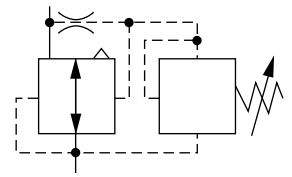

10 bar spring

Relieving

11-818-110 G¹/₄

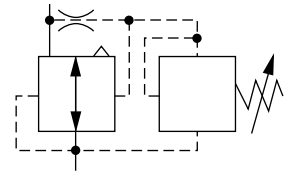

0,5 bar spring

Relieving

11-818-999 G¹/₄

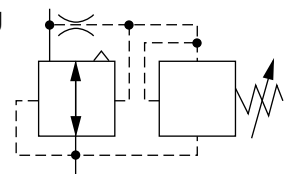

[†]Note: $\varnothing 17,5$ and up to 6 mm max. panel thickness when used with optional panel mounting nut reference 3081-01. To order see Accessories.

Spares Kits

Type	Minor Repair Kit	Major Overhaul Kit
Standard Pressure	2787-01	2787-98
High Pressure	2787-02	2787-97
Low Pressure	2787-99	2787-96

Warning

These products are intended for use in industrial compressed air systems only. Do not use these products where pressures and temperatures can exceed those listed under 'Technical Data'.

Before using these products with fluids other than those specified, for non-industrial applications, life-support systems, or other applications not within published specifications, consult NORGREN.

Through misuse, age, or malfunction, components used in fluid power systems can fail in various modes. The system designer is warned to consider the failure modes of all component parts used in fluid power systems and to provide adequate safeguards to prevent personal injury or damage to equipment in the event of such failure.

System designers must provide a warning to end users in the system instructional manual if protection against a failure mode cannot be adequately provided.

System designers and end users are cautioned to review specific warnings found in instruction sheets packed and shipped with these products.