

# Blowers & Fans

Centrifugal Blower

## 透浦式鼓風機



IE3

Premium Efficiency



### CHUAN FAN



台灣產品新型專利第 339596 • 345887 • 205327 • 142704 • 375137 • M425944 號  
中國產品新型專利第 1243826 號

## 用途

- 印刷機械
- 燃燒機
- 塑膠押出機、吹袋機淋膜機
- 製果機械
- 集塵機
- 環境機械
- 熱風發生機
- 粉粒體輸送
- 廚房機械
- 木工機械
- 乾燥機
- 焚化爐
- 恆溫箱
- 機械冷卻
- 一般送風



CX 透浦式



HTB 透浦多級式



TB 透浦式

## 特點

- 高壓·大風量·低噪音·輕量化
- 採用鋁合金材質，大幅降低重量，達到輕量化的目的。
- 馬達為 I.E.C. 設計 (1 HP 以上)，全閉外扇型鋁框馬達，特殊軸心設計，可適合長時間使用。
- 特殊葉片設計，壓力高·風量大·噪音低·壽命長。
- 特殊風量調節風門，風量控制穩定性高，操作容易 (CX.TB.HTB 適用)。
- 樣式種類齊全·庫存多·交貨迅速。

## Applications

- Printing Machines
- Burning Machines
- Plastic Extruders, Laminating, Film Making Machines
- Uniform Temperature Equipment
- Household Machines
- Dust Collectors
- Textile Machines
- Pollution Machines
- Hot Air Blowers
- Dryers Machines
- Incinerators
- Machinery for the Food and Beverage Industries
- Machinery for Cooling
- Woodworking Machines
- Grain elevators



低壓鑄造機  
*Low Pressure Casting Machines*



重力壓鑄機  
*Gravity Die Casting Machines*



壓鑄機  
*Die Casting Machines*



CNC 加工區  
*CNC Vertical Lathe*



IE3全自動馬達繞線/  
入線/整形機與生產線  
*IE3 Automatic motor Stator winding/  
Wedge Inserter/ Coil Forming  
Machinery and Production Line*



馬達組裝與自動測試  
*Motor Assembly & Test Line*

## Features

- High pressure • Larger flow • Light weight
- Aluminum alloy material was Widespread be use, offer light products.
- I. E. C. Designed motor (1HP UP), Squirrel Cage Induction Motors & specially designated shaft can satisfy long-time-continue operation.
- Professional impeller designed, high pressure, larger flow • low noise • and long life.
- Special air-flow-adjust designs offer stable flows and easily control.
- Full range styles and sufficiently finished products of each model make quickly delivery be possible.



## 透浦式鼓風機 Turbo Blower (Centrifugal Blower)

at 50/60HZ

型式 Type	相數 Phase	功率 Output (KW)	電壓 Voltage (V)	電流 Current (A)	最大靜壓 (吐出) Pressure (Max.) (kpa)	最大風量 (吐出) Air Flow (Max.) (m <sup>3</sup> /min)	吸入/吐出 口徑 In/Out Let (mm)	噪音 Noise Level (dB)	重量 Weight (Kg)
CX-65	1~ 3~	0.2	220 220/380	1.5 1.1/0.9	0.7/1.1	4.5/5.3	IN 100 OUT 65	50/62	6
CX-75SA	1~ 3~	0.4	220 220/380	2.5 1.9/1.2	1.1/1.6	7/8	IN 100 OUT 75	56/70	9
CX-75A	1~ 3~	0.74	220 220/380	5 3/1.9	1.7/2.4	13/15	IN 125 OUT 100	64/80	16
CX-100A	3~	1.5	220/380	5.5/3.5	2/3	20/23	IN 125 OUT 100	74/90	26
CX-125A	3~	2.2	220/380	8/5	2.4/3.7	32/37	IN 200 OUT 125	76/95	36
CX-150A	3~	3.7	220/380	13/7.5	3.2/4.4	46/53	IN 252 OUT 150	80/100	56

### 性能表 Characteristic curves

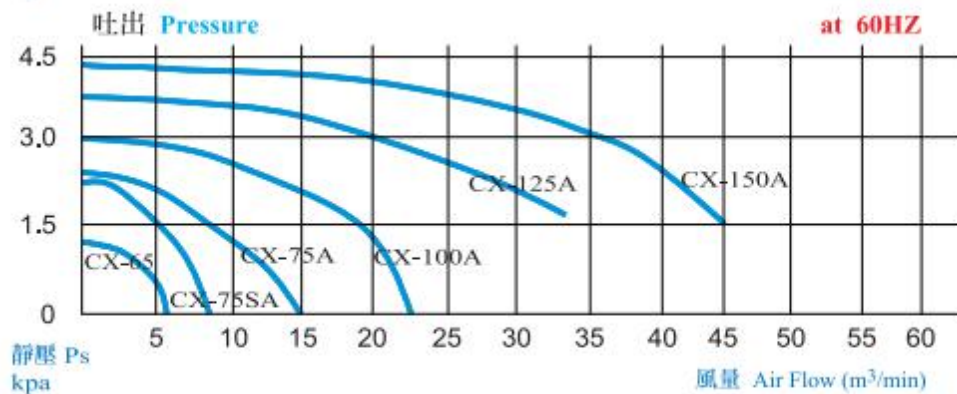
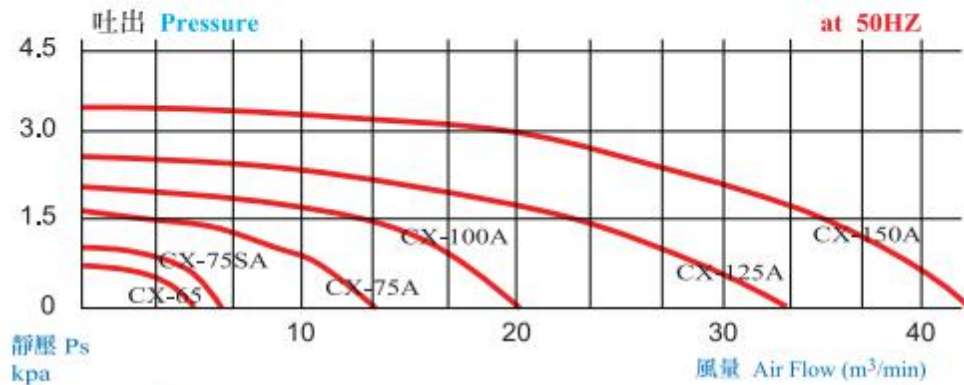



## 透浦式鼓風機 Turbo Blower (Centrifugal Blower)

at 50/60HZ

型式 Type	相數 Phase	功率 Output (KW)	電壓 Voltage (V)	電流 Current (A)	最大靜壓 (吐出) Pressure (Max.) (kpa)	最大風量 (吐出) Air Flow (Max.) (m <sup>3</sup> /min)	出口 口徑 Out Let	噪音 Noise Level (dB)	重量 Weight (Kg)
TB100-1	3~	0.75	220 380	3 1.8	1.3/2.1	18/22	100mm	70/80	22
TB100-2	3~	1.5	220 380	5.5 3.5	2/3	20/25	100mm	70/85	26
TB125-3	3~	2.2	220 380	8 5	2.4/3.6	33/39	125mm	80/90	35
TB150-5	3~	3.7	220 380	13 7.5	3.8/5.3	48/53	150mm	90/95	57
TB150-7.5	3~	5.5	220 380	19 11.5	3.8/5.3	50/65	150mm	90/95	66
TB150-10	3~	7.5	220 380	26 15.5	3.8/5.3	60/75	150mm	90/95	75
TB150L-10	3~	7.5	220 380	26 15.5	5/6.5	40/53	150mm	90/100	80
TB200-15	3~	11	220 380	36 22	5/6.5	65/85	200mm	95/110	130
TB200-20	3~	15	220 380	47 28	5/7	90/100	200mm	95/110	140

### 性能表 Characteristic curves

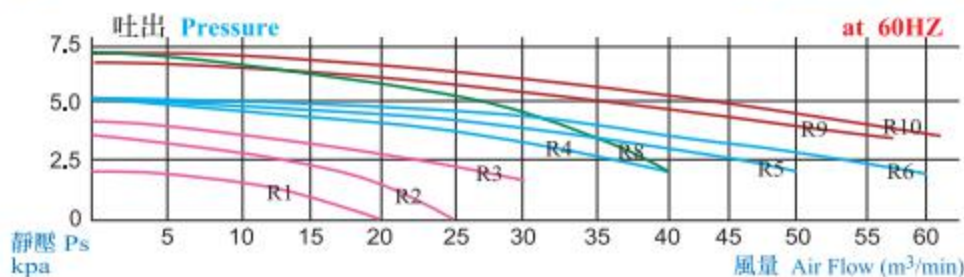
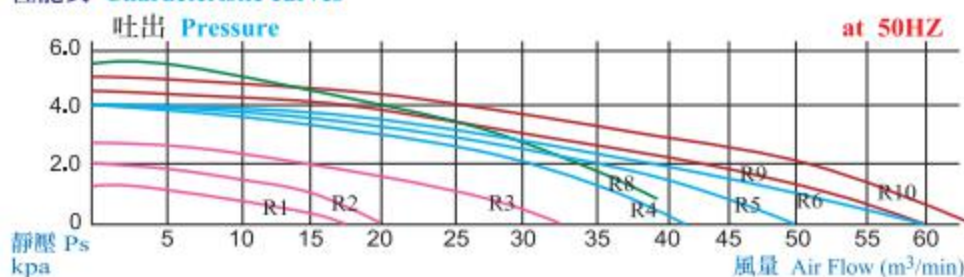

編號	品名	編號	品名	編號	品名	編號	品名
R1	TB100-1	R2	TB100-2	R3	TB125-3	R4	TB150-5
R5	TB150-7.5	R6	TB150-10	R8	TB150L-10	R9	TB200-15
R10	TB200-20						





透浦多段式鼓風機 **Multi-Stage Turbo Blower (Centrifugal Blower)**  
at 50/60HZ

型式 Type	相數 Phase	功率 Output (KW)	電壓 Voltage (V)	電流 Current (A)	最大靜壓 (吐出) Pressure (Max.) (kpa)	最大風量 (吐出) Air Flow (Max.) (m <sup>3</sup> /min)	出口 口徑 Out Let (mm)	噪音 Noise Level (dB)	重量 Weight (Kg)
HTB75-032	3~	0.4	220 380	1.9 1.2	2.1/2.6	6/7	75mm	53/65	16
HTB75-053	3~	0.4	220 380	1.9 1.2	2.9/3.8	6.5/7.5	75mm	55/68	18
HTB75-104	3~	0.75	220 380	3 1.8	3.7/5	6.5/8	75mm	56/70	24
HTB75-105	3~	0.75	220 380	3 1.8	4.2/6	6.8/8.5	75mm	56/70	27
HTB100-102	3~	0.75	220 380	3 1.8	3.4/4.5	11/13	100mm	60/74	25
HTB100-203	3~	1.5	220 380	5.5 3.5	5/7	11/14	100mm	61/76	33
HTB100-304	3~	2.2	220 380	8 5	6.5/9	12.5/16	100mm	63/78	41
HTB100-505	3~	3.7	220 380	13 7.5	7.9/11	12.8/16.5	100mm	64/80	53
HTB125-503	3~	3.7	220 380	13 7.5	5.8/7.9	19/23	125mm	70/85	62
HTB125-704	3~	5.5	220 380	19 11.5	7.5/10.5	20/24	125mm	70/88	87
HTB125-1005	3~	7.5	220 380	26 15.5	9/13	20/24	125mm	72/90	109
HTB200-1502	3~	11	220 380	36 22	7/9	52/65	200mm	86/109	150
HTB200-2002	3~	15	220 380	47 28	8/10	56/70	200mm	88/110	170
2HTB65-503	3~	3.7	220 380	13 7.5	12/16	11/13	PF2 1/2"	70/85	73
2HTB65-704	3~	5.5	220 380	19 11.5	15/21	12/14	PF2 1/2"	70/85	104
2HTB65-1005	3~	7.5	220 380	26 15.5	18/26	13/15	PF2 1/2"	70/85	118

性能表 **Characteristic curves**

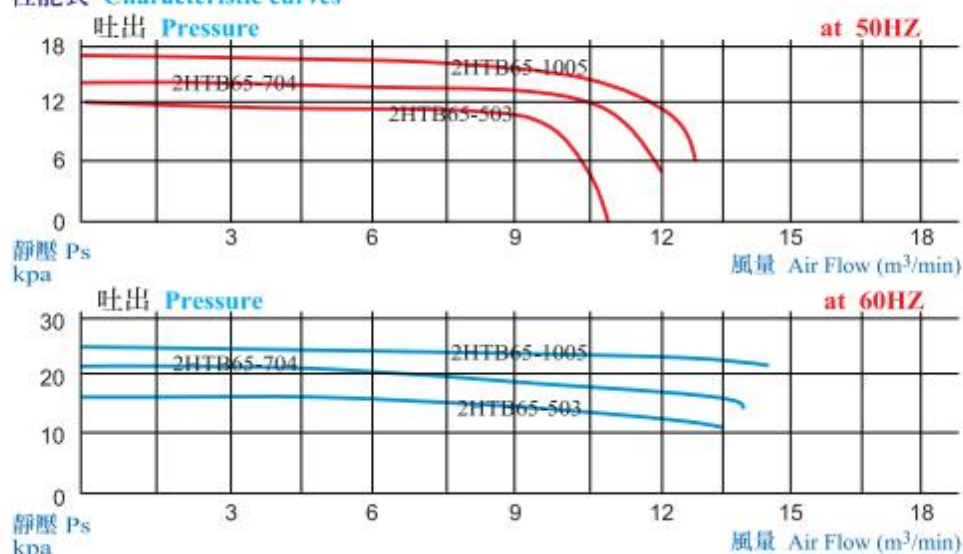



## 透浦多段式鼓風機 Multi-Stage Turbo Blower (Centrifugal Blower)

性能表 Characteristic curves

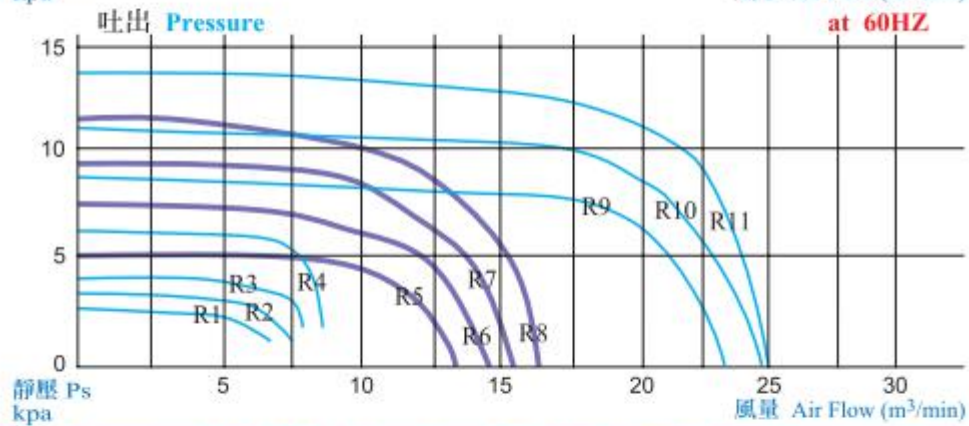
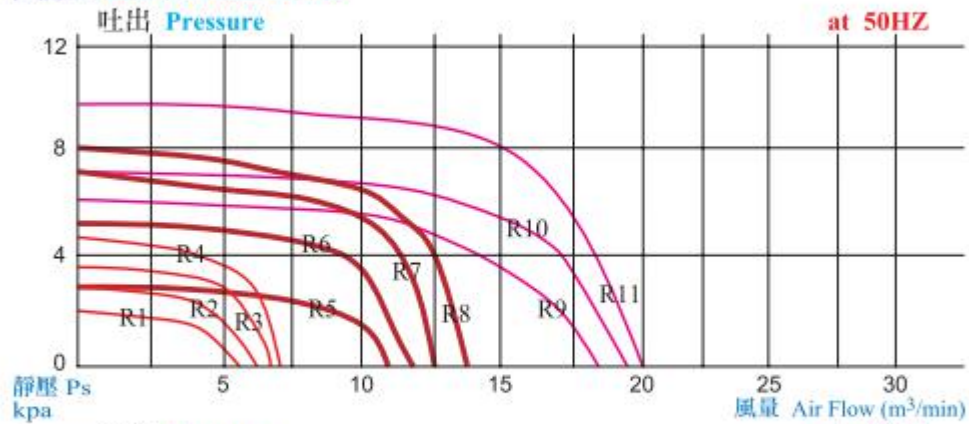

編號	品名	編號	品名	編號	品名	編號	品名
R1	HTB75-032	R2	HTB75-053	R3	HTB75-104	R4	HTB75-105
R5	HTB100-102	R6	HTB100-203	R7	HTB100-304	R8	HTB100-505
R9	HTB125-503	R10	HTB125-704	R11	HTB125-1005		

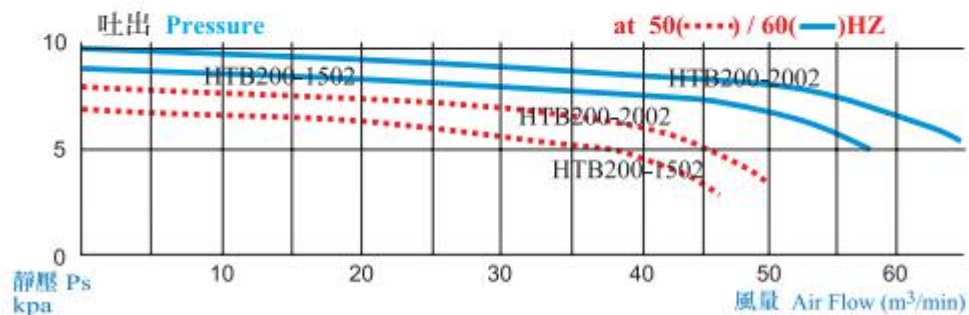

# 透浦多段式鼓風機 Multi-Stage Turbo Blower

尺寸圖 Dimension (mm)



**HTB75-032 2-stage**

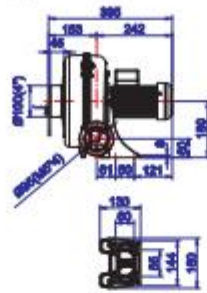

**HTB100-102 2-stage**

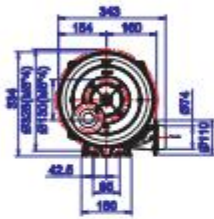

**HTB75-053 3-stage**

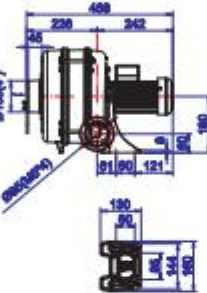

**HTB100-203 3-stage**

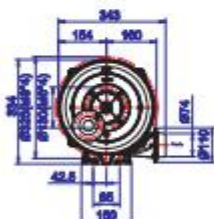
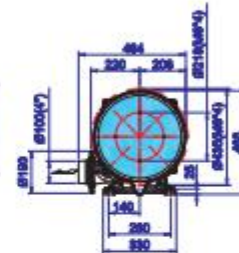

**HTB75-104 4-stage**

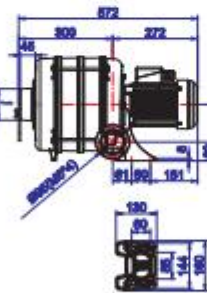

**HTB100-304 4-stage**

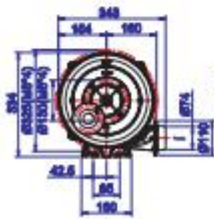
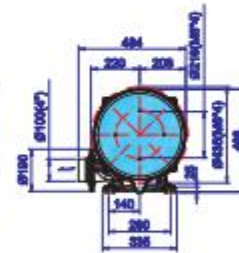

**HTB75-105 5-stage**

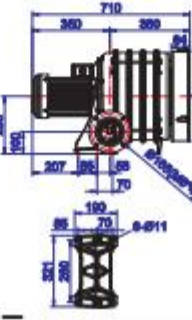
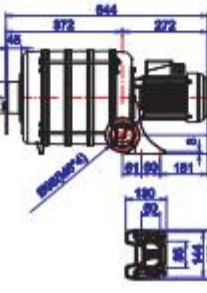

**HTB100-505 5-stage**

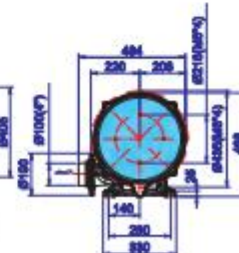

# 透浦多段式鼓風機 Multi-Stage Turbo Blower

尺寸圖 Dimension (mm)

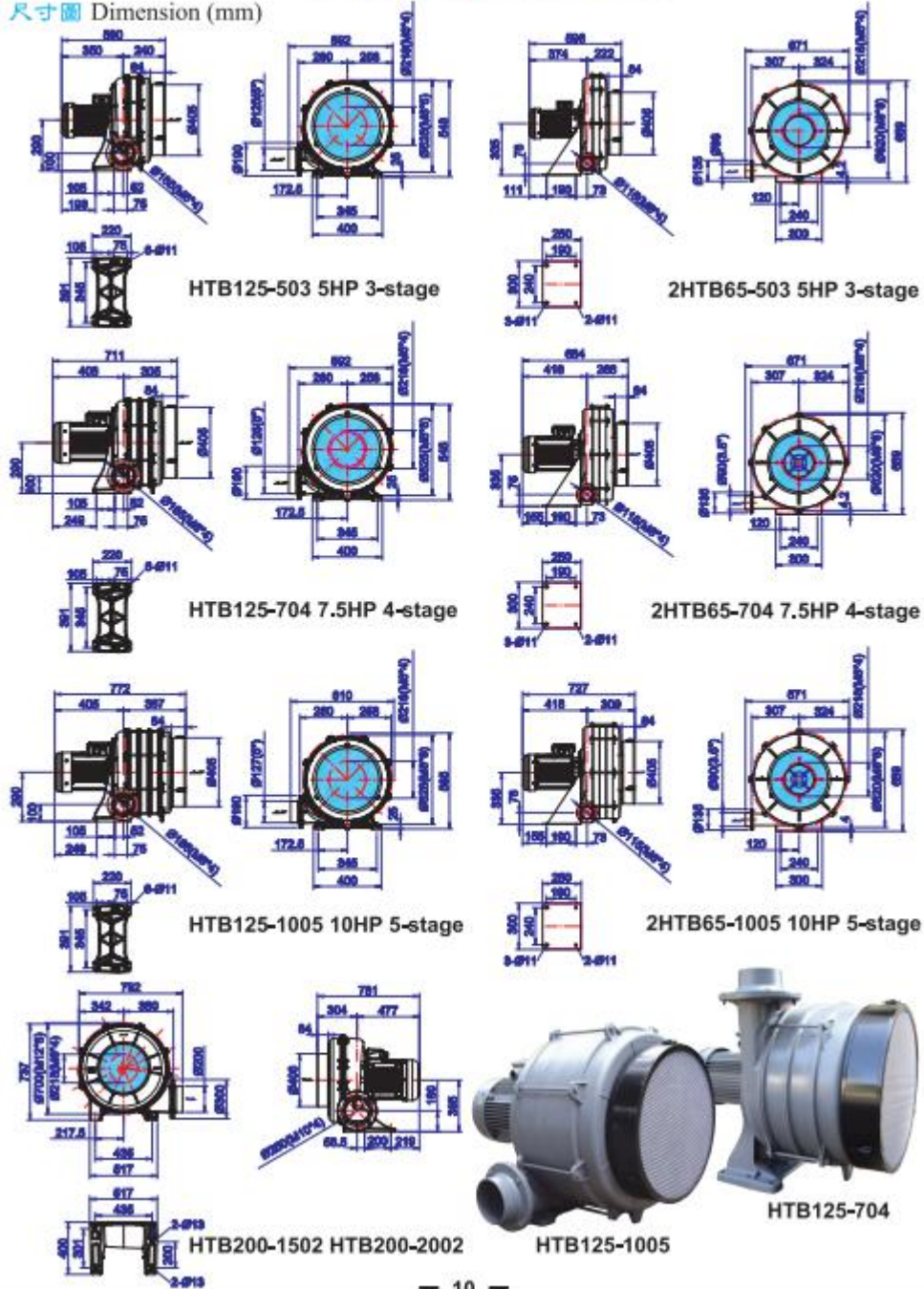



## 隔熱型鼓風機 Heat-Resistant Turbo Blower

at 50/60HZ

型式 Type	相數 Phase	功率 Output (KW)	電壓 Voltage (V)	電流 Current (A)	最大靜壓 (吐出) Pressure (Max.) (kpa)	最大風量 (吐出) Air Flow (Max.) (m <sup>3</sup> /min)	吸入/吐出 口徑 In/Out Let (mm)	噪音 Noise Level (dB)	重量 Weight (Kg)	最大吸氣 溫度 Suction Temperature (max)
CX-75SAH	1~ 3~	0.4	1Ø 220 220/380	2.5 1.9/1.2	1.1/1.6	7/8	IN 100mm OUT 75mm	56/70	10	180°C
CX-75AH	1~ 3~	0.74	1Ø 220 220/380	5 3/1.9	1.7/2.4	13/15	IN 125mm OUT 100mm	64/80	17	
CX-100AH	3~	1.5	220/380	5.5/3.5	2/3	20/23	IN 125mm OUT 100mm	74/90	28	
CX-125AH	3~	2.2	220/380	8/5	2.4/3.7	25/32	IN 125mm OUT 125mm	76/95	38	
CX-150AH	3~	3.7	220/380	13/7.5	3.2/4.4	35/45	IN 150mm OUT 150mm	80/100	59	

尺寸圖 Dimension (mm)

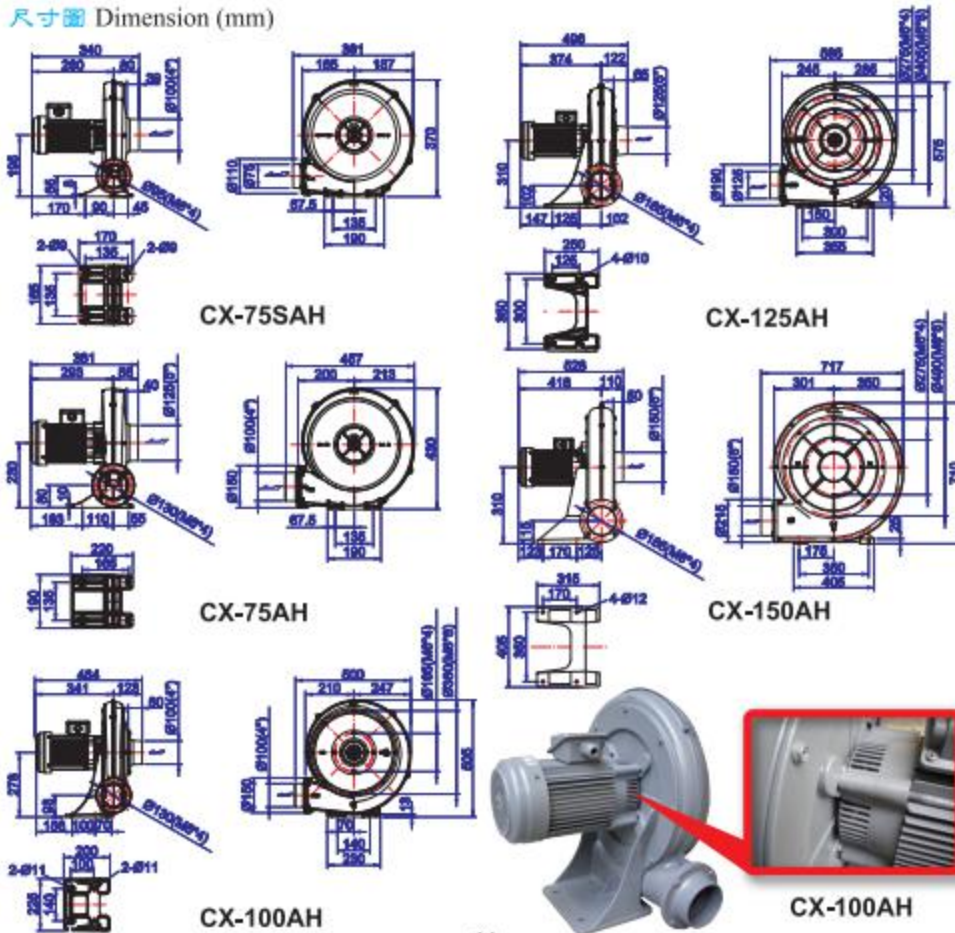

# 噴射氣送管 Air Jet Transportation Pipe

尺寸圖 Dimension (mm)

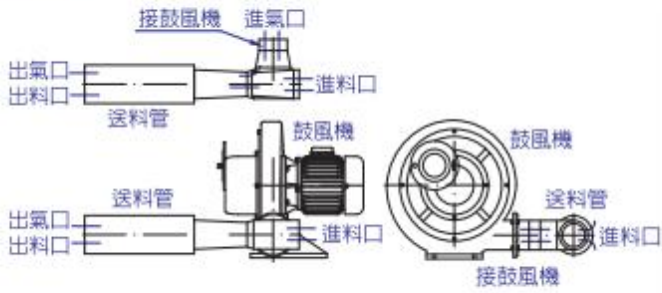

**JET 4" JET 6" JET 8"**

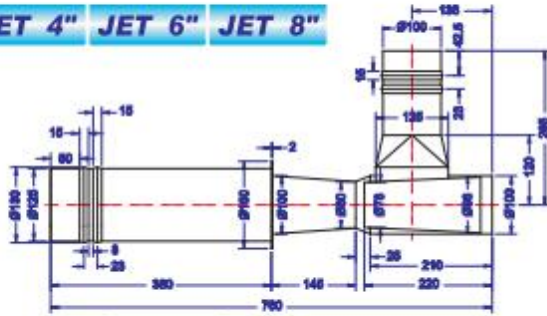

**JET 4"**

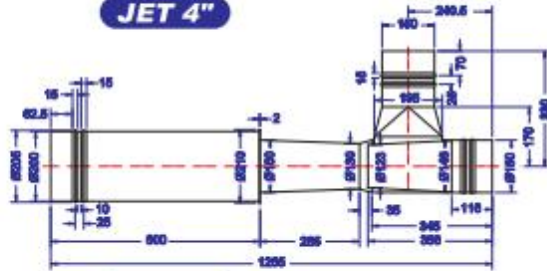

**JET 6"**

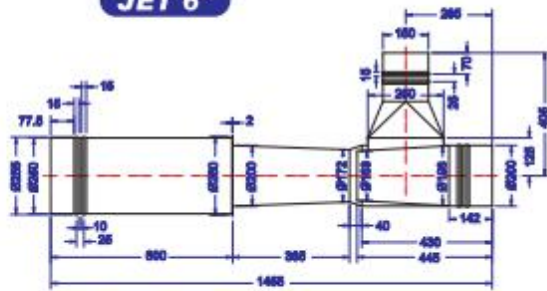

**JET 8"**



## 鋁合金高效率均壓風刀 ALUMINUM AIR KNIFE

**產品特點：**本風刀是由全風公司所研發，以鋁合金擠壓一體成型，雨滴型整流結構，風壓風量均勻，壓損低，構造單純，材質堅固，組裝容易。可調式出風口設計，出風口的氣流是單方向吹出設計，滿足多元化生產需要。

**Features :** The air knife is a research and development by Chuan Fan company. The extruded aluminum, raindrops rectifier structure, uniform air flow pressure, low pressure drop, simple structure, strong material, easy to assemble. Adjustable outlet design, the outlet air flow is blown in one direction designed to meet the diverse production needs.

**應用：**吹除工件表面的水份或油份、冷卻降溫、熱風吹乾等....。

**Application :** Blowing the surface of the water or oil, cooling, hot air drying, etc

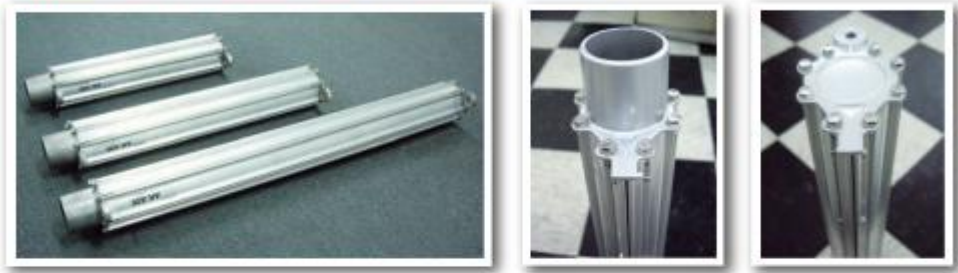

型號 MODEL	AK50-300-1	AK50-400-1	AK50-600-1	AK50-900-1 AK50-900-2	AK50-1200-1 AK50-1200-2
入風口徑/數量 Inlet diameter /Quantity	50mm X 1	50mm X 1	50mm X 1	50mm X 1 50mm X 2	50mm X 1 50mm X 2
長度 Length	300mm	400mm	600mm	900mm	1200mm
出風口寬度 Air outlet width	0.5~2mm	0.5~2mm	0.5~2mm	0.5~2mm	0.5~2mm

型號 MODEL	AK75-500-1	AK75-1000-1	AK75-1200-1 AK75-1200-2	AK75-1500-1 AK75-1500-2	AK75-1800-1 AK75-1800-2
入風口徑/數量 Inlet diameter /Quantity	75mm X 1	75mm X 1	75mm X 1	75mm X 1 75mm X 2	75mm X 1 75mm X 2
長度 Length	500mm	1000mm	1200mm	1500mm	1800mm
出風口寬度 Air outlet width	1~3mm	1~3mm	1~3mm	1~3mm	1~3mm

### 適用鼓風機概算

#### Estimates for Blowers

所需風量(m<sup>3</sup>/min)=[風刀長度(m)X出風口寬度(m)]x希望風速(m/sec)X60X(1.2~1.5)

Airflow(m<sup>3</sup>/min)= [Length (m) x Air outlet width (m)] x Wind speed (m/sec) x 60 x (1.2~1.5)

風刀出口寬度 Air outlet width	1mm	2mm	3mm	4mm
所需靜壓 Static pressure	10kPa以上 10kPa or more	5~15kPa	3~8kPa	2~5kPa

**P.S.** 上述資料須在(使用點)上計算

P.S. The above information is required (point of use) is calculated on



AK50

單向入口

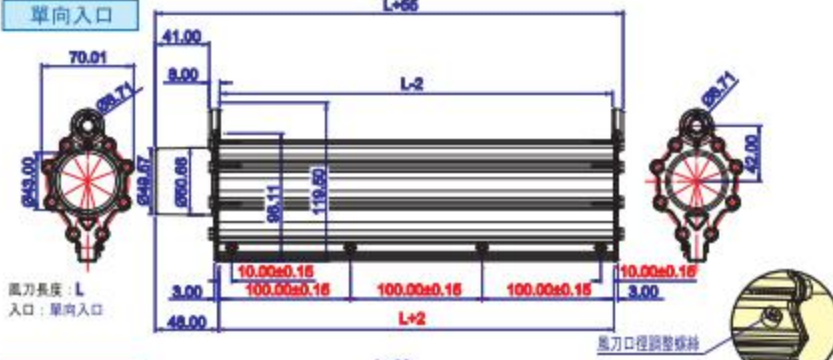

雙向入口

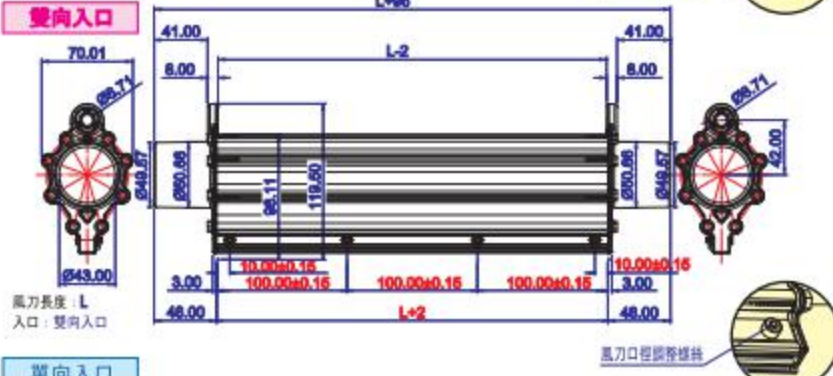

AK75

單向入口

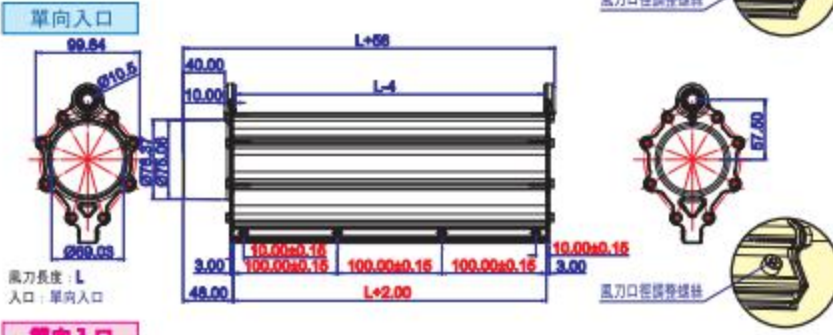

雙向入口

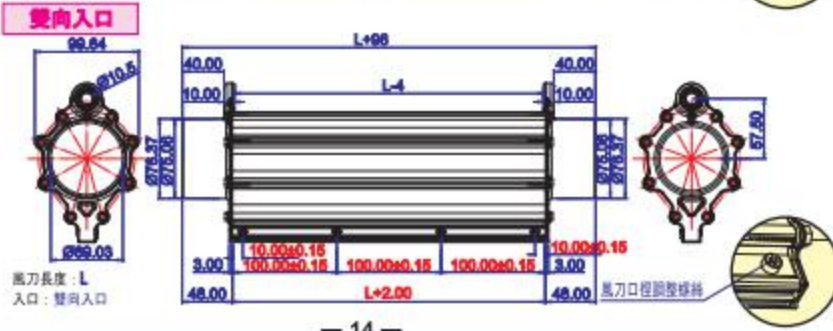



中國認證

GB18613-2012



GB19761-2009



UL/CAN



IE3 Motor



CE



CCC



批發・製造・買賣 manufacturer, distributor



全風機電股份有限公司  
全風風機股份有限公司  
CHUAN-FAN ELECTRIC CO., LTD.



營運部/揚梅廠：  
桃園市楊梅區(鈔獅工業區)青年路6-2號(鈔獅文成進南字旁)  
No.6-2 Qingnian Rd, Youth Industrial Park, Yangmei Dist,  
Taoyuan City 32661, Taiwan

Tel:886-3-4643788 Fax:886-3-4643771

銅鑄廠：苗栗縣銅鑄鄉鈔獅工業區自強路23號

Tel:037-980-722 Fax:037-980-725



台北門市：新北市三重區光復路一段28號

Tel:02-2995-3388 Fax:02-2995-2295

高雄門市：高雄市九如一路214巷11號(大和交通通車上車)

Tel:07-380-9512 Fax:07-380-9677

<http://www.chuanfan.com>

<http://www.chuanfan.com.tw>

e-mail: [service@chuanfan.com](mailto:service@chuanfan.com)

2016.04.01