

B3F

轻触式开关

6mm方形、12mm方形
具有垂直型、高荷重、
镀金型等全系列产品

- 实现轻快的按触感及高耐久性
- 备有可用于通用的径向带状部件插入机的带状规格
- 备有可以在长时间内保持稳定接触和绝缘的镀金型。
- 可安装键顶(B32系列)，有凸型柱塞。

符合RoHS

B
3
F

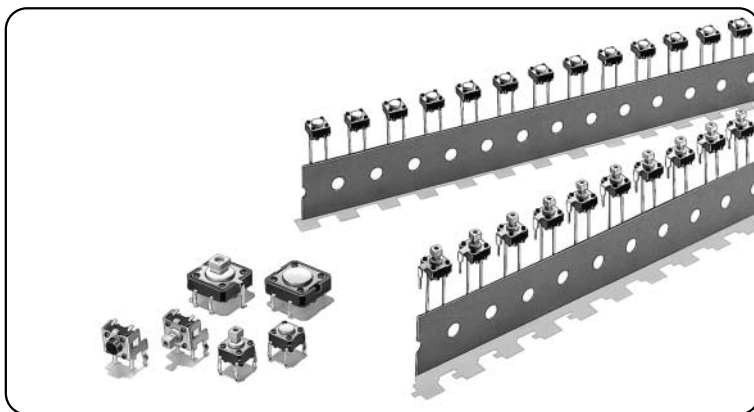

■ 种类

6mm方形

型号	柱塞的种类	高度	接地端子 发货形态 动作力	无	有
				袋装 (100个/袋)	
6mm方形 标准型 (B3F-1000系列)	(平型)	4.3mm	0.98N	B3F-1000	B3F-1100
			1.47N	B3F-1002	B3F-1102
			2.55N	B3F-1005	B3F-1105
			4.9N	B3F-1006 *	—
		5.0mm	0.98N	B3F-1020	B3F-1120
			1.47N	B3F-1022	B3F-1122
			2.55N	B3F-1025	B3F-1125
			4.9N	B3F-1026 *	—
	5.0mm (7.5mm节距)	0.98N	—	B3F-1110	
	7.0mm	0.98N	B3F-1060	—	
		1.47N	B3F-1062	—	
	9.5mm	0.98N	B3F-1070	—	
		1.47N	B3F-1072	—	
	(凸型)	7.3mm	0.98N	B3F-1050	B3F-1150
1.47N			B3F-1052	B3F-1152	
2.55N			B3F-1055	B3F-1155	
4.9N			B3F-1056 *	—	
3.15mm		0.98N	—	B3F-3100	
		1.47N	—	B3F-3102	
6mm方形 立式型 (B3F-3000系列)	(平型)	3.85mm	2.55N	—	B3F-3105
			0.98N	—	B3F-3120
			1.47N	—	B3F-3122
	(凸型)	6.15mm	2.55N	—	B3F-3125
			0.98N	—	B3F-3150
			1.47N	—	B3F-3152
6mm方形 镀金型 (B3F-G系列)	(平型)	4.3mm	1.76N	B3F-1002-G	B3F-1102-G
		5.0mm		B3F-1022-G	B3F-1122-G
		7.0mm		B3F-1062-G *	—
		9.5mm		B3F-1072-G *	—
	(凸型)	7.3mm		B3F-1052-G *	—
		(平型)		3.85mm	—

注. 袋装发货数量100个/袋, 定货需100个的整数倍。

12mm方形

型号	柱塞的种类	高度	动作力	接地端子	
				无	有
发货形态				袋装 (100个/袋)	
12mm方形 标准型 (B3F-4000系列)	平型	4.3mm	1.27N	B3F-4000	B3F-4100
			2.55N	B3F-4005	B3F-4105
	凸型	7.3mm	1.27N	B3F-4050	B3F-4150
			2.55N	B3F-4055	B3F-4155
12mm方形 长寿型 (B3F-5000系列)	平型	4.3mm	1.27N	B3F-5000	B3F-5100
	凸型	7.3mm		B3F-5050	B3F-5150
12mm方形 高信赖型 (B3F-5001系列)	平型	4.3mm	1.27N	B3F-5001	B3F-5101
	凸型	7.3mm		B3F-5051	B3F-5151

注. 订货需100个的整数倍。

6mm方形柱塞型(袋装规格)

型号	柱塞的种类	高度	动作力	接地端子	
				无	有
柱塞型 (B3F-6000系列)	平型	4.3mm	0.98N	B3F-6000	B3F-6100
			1.47N	B3F-6002	B3F-6102
		5.0mm	0.98N	B3F-6020	B3F-6120
			1.47N	B3F-6022	B3F-6122
	凸型	7.3mm	0.98N	B3F-6050	B3F-6150
			1.47N	B3F-6052	B3F-6152

注. 订货需1,000个的整数倍。注意不可以端子数发货。

■ 额定值/性能

电气额定值	DC5~24V 1~50mA 阻性负载 (B3F-G系列: DC5~24V 100μA~50mA)
使用环境温度	-25~+70℃ (无结冰)
使用环境湿度	35~85%RH
接点构成	1a常开接点
接触电阻	100mΩ以下 (初始值) (DC5V 1mA通电) (B3F-G系列: DC5V 100μA通电)
绝缘电阻	100MΩ以上 (DC250V兆欧表)
耐压	AC500V 50/60Hz 1min
外壳	5ms以下
振动	误动作 频率10~55Hz 双振幅1.5mm
冲击	耐久 最大1,000m/s ²
	误动作 最大100m/s ²
寿命	B3F-1000系列、B3F-3000系列、B3F-6000系列 100万次以上 (OF:0.98N型、B3F-1070在50万次以上) 30万次以上 (OF:1.47N型) 10万次以上 (OF:2.55N型) 5万次以上 (OF:4.9N型) B3F-4000系列 300万次以上 (OF:1.27N型) 100万次以上 (OF:2.55N型) B3F-5000系列:1000万次以上 B3F-G系列:30万次以上
质量	6mm方形: 约0.25g、12mm方形: 约0.85g (标准数值)、开孔形: 约0.25g

■ 动作特性

类型	B3F-1000、-3000、-6000系列				B3F-4000、-5000系列		B3F-G系列
	0.98N型	1.47N型	2.55N型	4.9N型	1.27N型	2.55N型	1.76N型
项目	B3F-1□□0 B3F-3□□0 B3F-6□□0	B3F-1□□2 B3F-3□□2 B3F-6□□2	B3F-1□□5 B3F-3□□5	B3F-10□□6	B3F-4□□0 B3F-5□□0	B3F-4□□5	B3F-1□□2-G B3F-3□□2-G
动作力 (OF)	0.98±0.29N	1.47±0.49N	2.55±0.69N	4.9±1.47N	1.27±0.49N	2.55±0.69N	1.76±0.49N
回复力 (RF)	最小0.2N	最小0.49N	最小0.49N	最小0.7N	最小0.29N	最小0.49N	最小0.49N
过行程 (PT)	0.25 ^{+0.1} _{-0.1} mm				0.3 ^{+0.1} _{-0.1} mm		0.25 ^{+0.1} _{-0.1} mm

■外形尺寸 (单位:mm)

6mm方形

注. 正常状态下BOTTOM VIEW “OMRON” 的标识 (见右图), 端子型号如右图。
(横压型和径向型除外)



●标准型、平型 (无接地端子)

B3F-1000 B3F-1002 B3F-1005 B3F-1006
B3F-1020* B3F-1022* B3F-1025* B3F-1026*
B3F-1002-G
B3F-1022-G*

型号	CAD文件
B3F-100□	B3F_01
B3F-102□	B3F_02

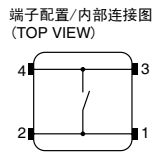
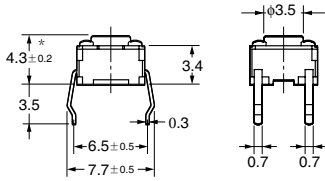
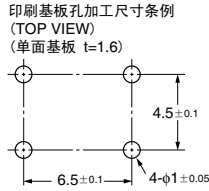
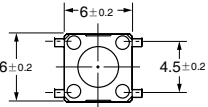
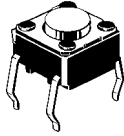

* B3F-1020、B3F-1022、B3F-1025、B3F-1026、B3F-1022-G高度在5±0.2mm

●标准型、平型 (有接地端子、间距6.5mm)

B3F-1100 B3F-1102 B3F-1105
B3F-1120* B3F-1122* B3F-1125*
B3F-1102-G
B3F-1122-G*

型号	CAD文件
B3F-110□	B3F_04
B3F-112□	B3F_05

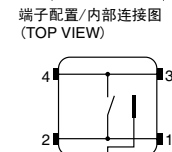
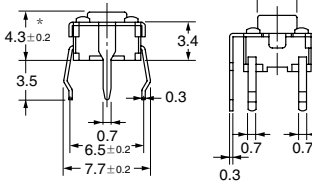
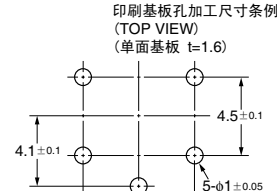
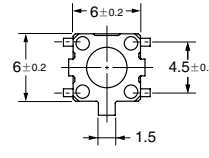
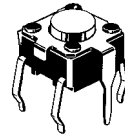

* B3F-1120、B3F-1122、B3F-1125、B3F-1122-G高度在5±0.2mm

●标准型、平型 (有接地端子、间距7.5mm)

B3F-1110

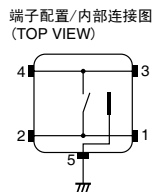
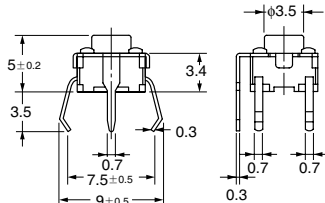
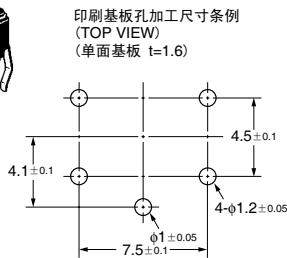
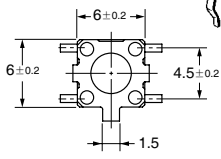
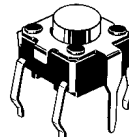

●标准型、平型 (无接地端子)

B3F-1060 B3F-1062 B3F-1062-G

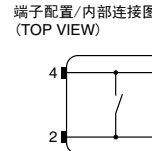
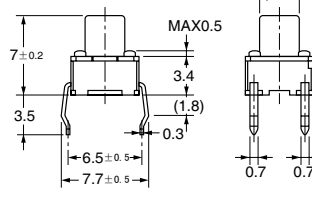
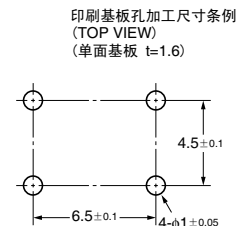
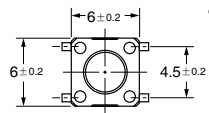
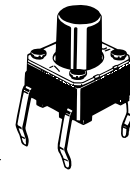

●标准型、平型 (无接地端子)

B3F-1070 B3F-1072-N B3F-1075 B3F-1072-G

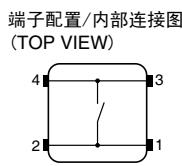
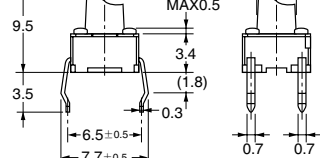
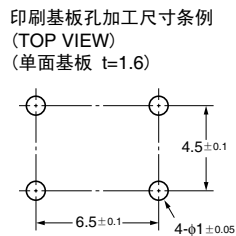
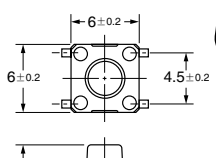
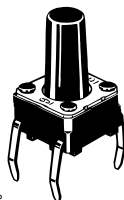

●标准型、凸型 (无接地端子)

B3F-1050 B3F-1052
B3F-1055 B3F-1056
B3F-1052-G

CAD文件 B3F_03

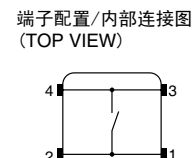
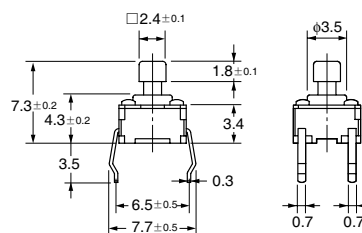
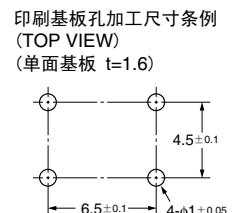
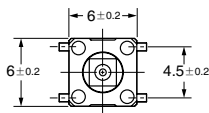
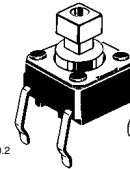

注. 上述外形尺寸图中, 未注公差为±0.4mm. 开关本体的端子型号没有表示.

●标准型、凸型（有接地端子）

B3F-1150 B3F-1152 B3F-1155

CAD文件 B3F_06

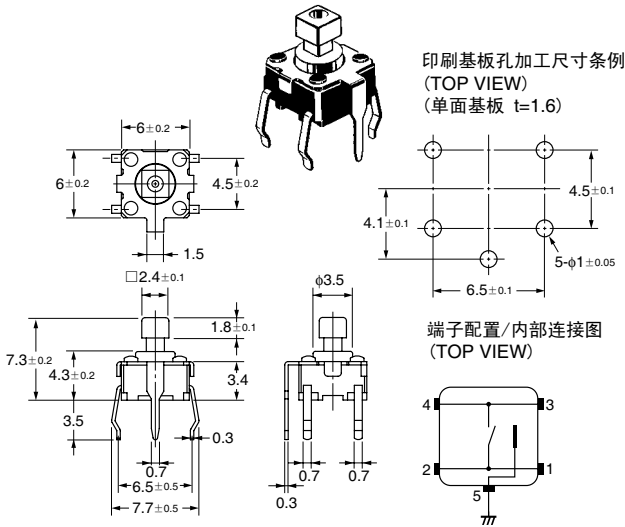

●立式型、平型

B3F-3100 B3F-3102 B3F-3105

CAD文件 B3F_07

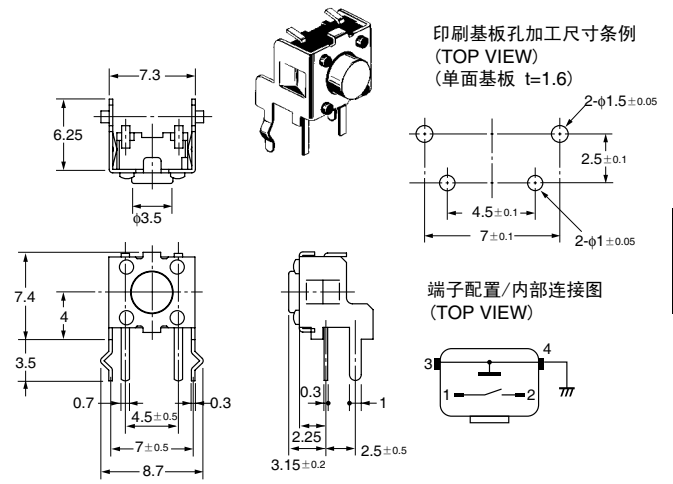

●立式型、平型（高度3.85m）

B3F-3120 B3F-3122 B3F-3125
B3F-3122-G

CAD文件 B3F_08

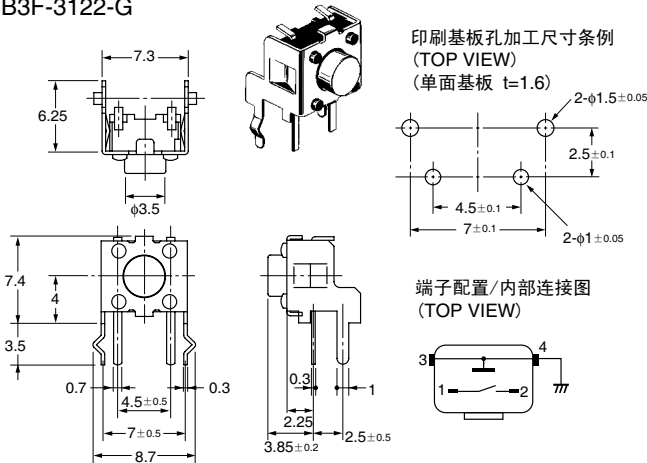

●立式型、凸型

B3F-3150 B3F-3152 B3F-3155

CAD文件 B3F_09

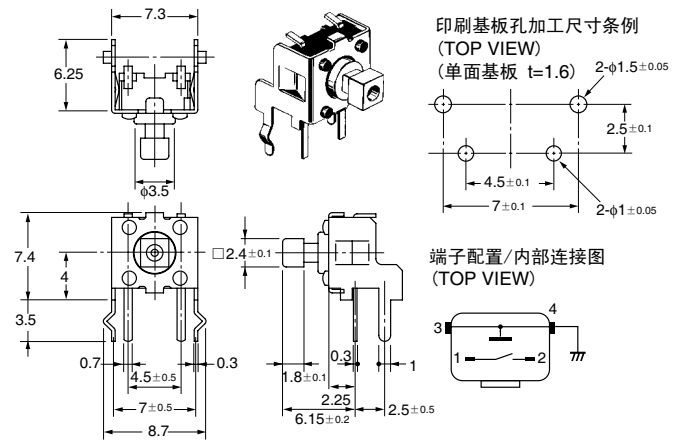

注. 上述外形尺寸图中, 未注公差为±0.4mm. 开关本体的端子型号没有表示。

12mm方形

●标准型、长寿命型、高信赖型
平型（无接地端子）

B3F-4000 B3F-4005
B3F-5000 B3F-5001

CAD文件 B3F_14

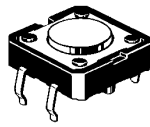

印刷基板孔加工尺寸条例
(TOP VIEW)
(单面基板 t=1.6)

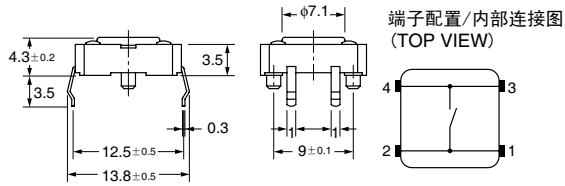
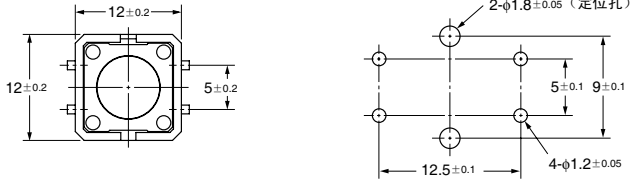

●标准型、长寿命型、高信赖型
平型（有接地端子）

B3F-4100 B3F-4105
B3F-5100 B3F-5101

型号 CAD文件
B3F-410□ B3F_11

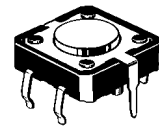

印刷基板孔加工尺寸条例
(TOP VIEW)
(单面基板 t=1.6)

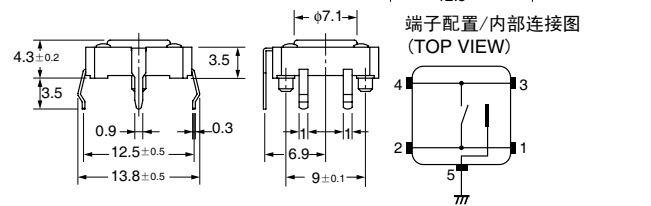
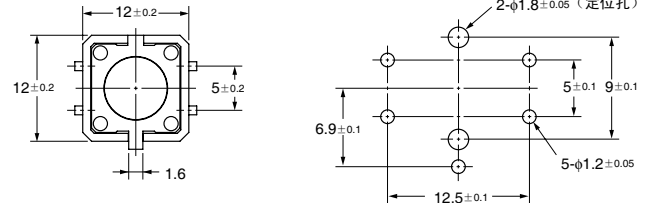

●标准型、长寿命型、高信赖型
凸型（无接地端子）

B3F-4050 B3F-4055
B3F-5050 B3F-5051

CAD文件 B3F_10

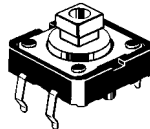

印刷基板孔加工尺寸条例
(TOP VIEW)
(单面基板 t=1.6)

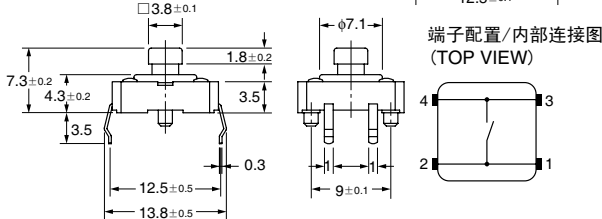
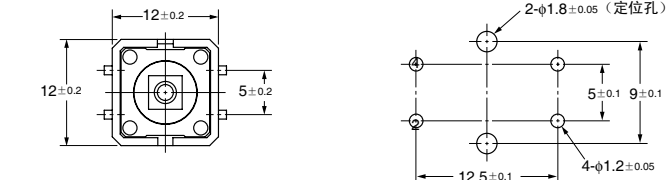

●标准型、长寿命型、高信赖型
凸型（有接地端子）

B3F-4150 B3F-4155
B3F-5150 B3F-5151

CAD文件 B3F_12

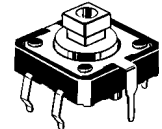

印刷基板孔加工尺寸条例
(TOP VIEW)
(单面基板 t=1.6)

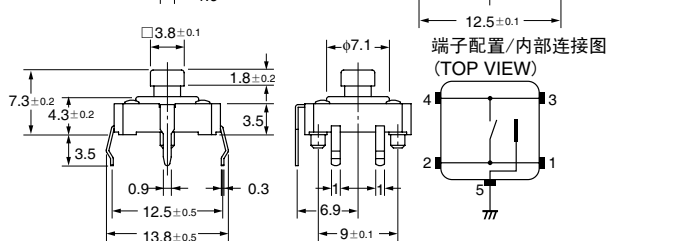
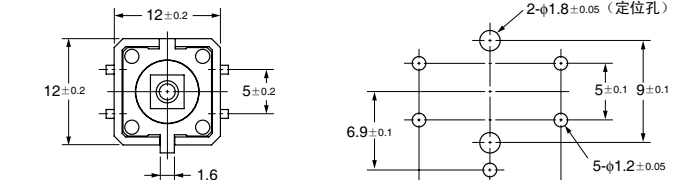

注. 上述外形尺寸图中, 未注公差为±0.4mm。

6mm方形柱塞型 (袋装规格)

注: 正常状态下BOTTOM VIEW “OMRON”的标识 (见右图), 端子型号如右图。



●平型 (无接地端子)

B3F-6000
B3F-6002

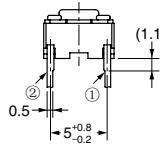
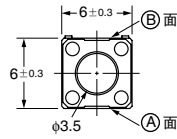
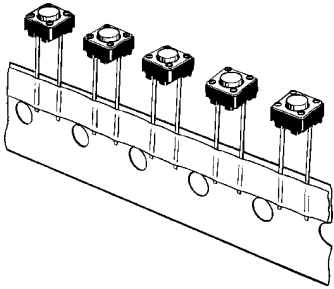

印刷基板孔加工尺寸条例
(TOP VIEW)
(单面基板t=1.6)

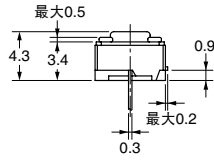
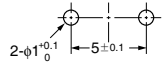

端子配置/内部连接图
(TOP VIEW)

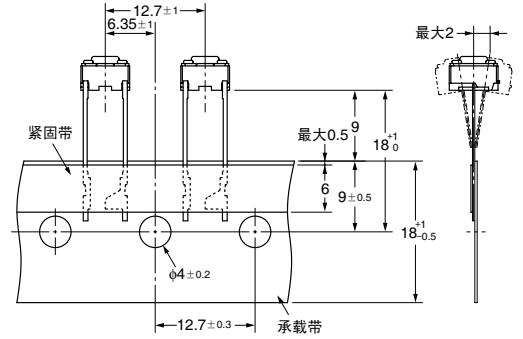
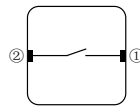

注: 带子的方向随机为A面或B面

●平型 (有接地端子)

B3F-6100
B3F-6102

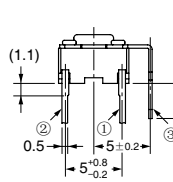
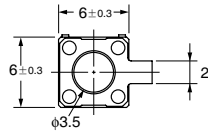
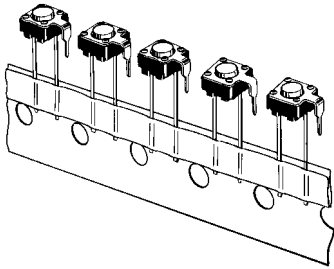

印刷基板孔加工尺寸条例
(TOP VIEW)
(单面基板t=1.6)

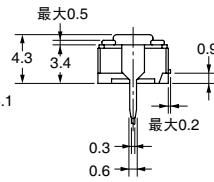
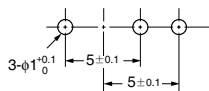

端子配置/内部连接图
(TOP VIEW)

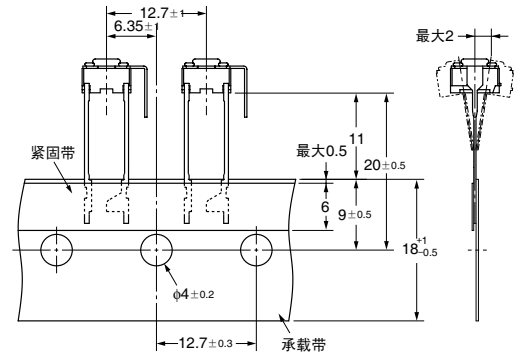
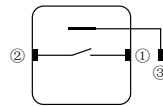

●平型 (无接地端子)

B3F-6020
B3F-6022

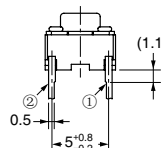
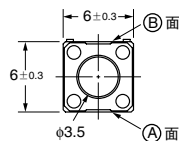
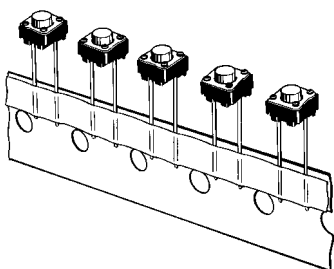

印刷基板孔加工尺寸条例
(TOP VIEW)
(单面基板t=1.6)

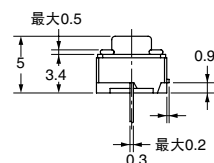
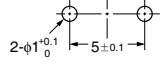

端子配置/内部连接图
(TOP VIEW)

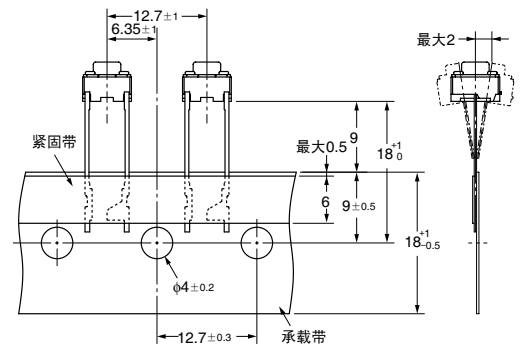
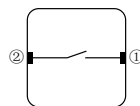

注: 带子的方向随机为A面或B面

注: 上述的各种机型外型尺寸, 没有指定部分的公差为±0.4mm。开关本体的端子型号没有表示。

● 平型 (有接地端子)

B3F-6120
B3F-6122

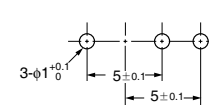
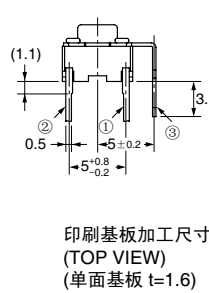
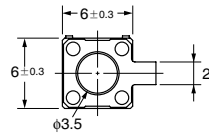
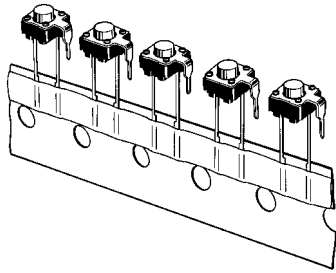

端子配置/内部接线图
(TOP VIEW)

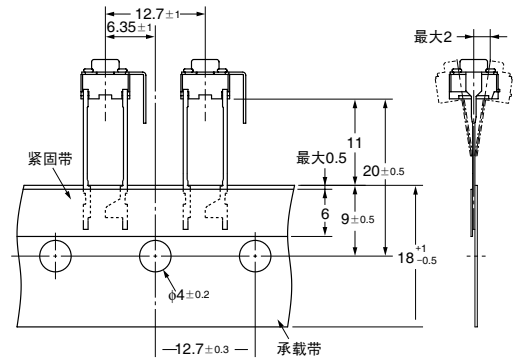
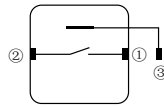

印刷基板加工尺寸
(TOP VIEW)
(单面基板 t=1.6)

● 凸型 (无接地端子)

B3F-6050
B3F-6052

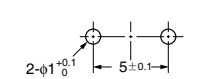
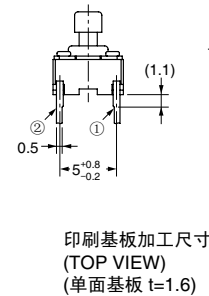
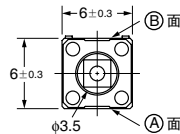
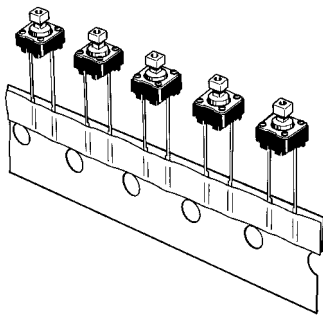

端子配置/内部接线图
(TOP VIEW)

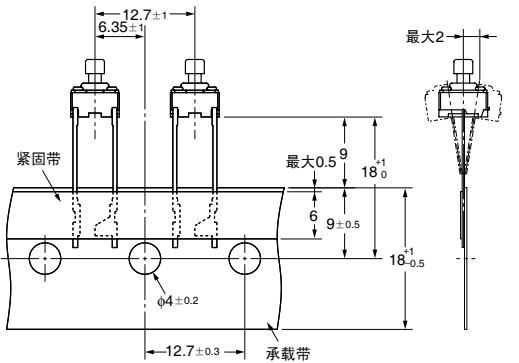
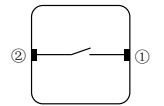

印刷基板加工尺寸
(TOP VIEW)
(单面基板 t=1.6)

注. 带子的方向随机为A面或B面

● 凸型 (有接地端子)

B3F-6150
B3F-6152

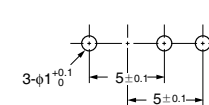
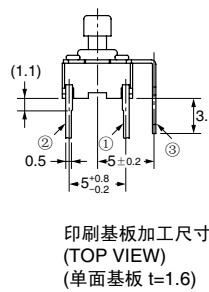
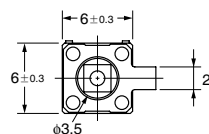
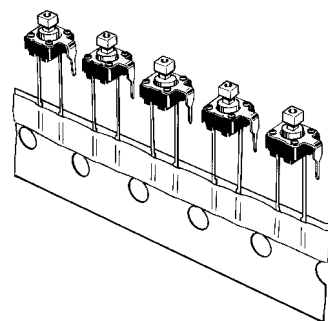

端子配置/内部接线图
(TOP VIEW)

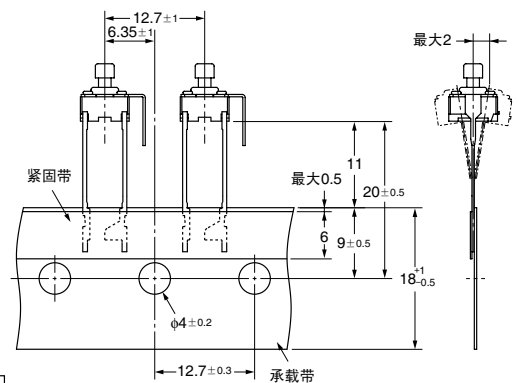
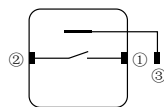

注. 上述的各种机型外型尺寸, 没有指定部分的公差为±0.4mm。开关本体的端子型号没有表示。

■ 键顶

凸柱塞型, 备有专用的键顶及B32型系列详细内容请参见有关章节。

■ 请正确使用

★「共通注意事项」请参考相关页。