

STORM AC AXIAL FAN 120x120x38mm Series

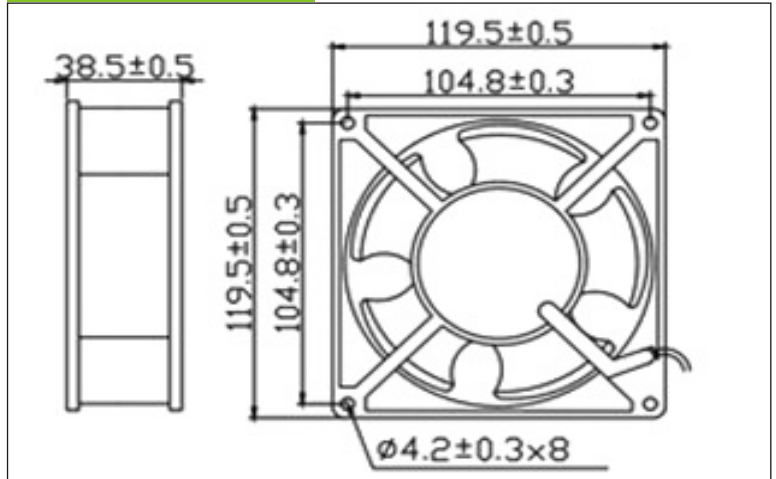

Dimensions (mm)



CONSTRUCTION:

- *Die-cast aluminum housing
- *Glass fiber reinforced plastic: Impeller are UL94-0 rating
- *Impedance portected
- *leader wire or terminal is available

OPERATING TEMPERATURE:

- *Ball bearing -30°C to +75°C
- *Sleeve bearing -10°C to +70°C

Performance Ccurve

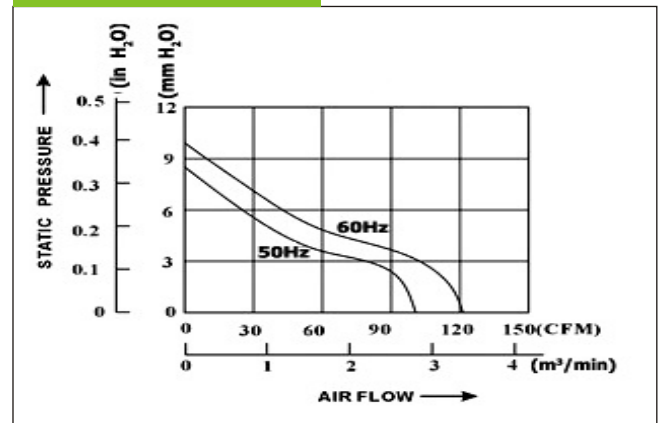

Model	Spec	RATED (VDC)	FREQ. (Hz)	CURRT (Amp)	POWER (Watts)	SPEED (Rpm)	AIR FLOW (CFM)	PRESSURE (In H ₂ O)	NOISE (dB-A)	Weight (g)
SA12038HB-11K		100/120	50/60	0.25/0.19	18/13	2550/2900	89/115	0.30/0.35	45/51	520
SA12038HB-22K		200/240	50/60	0.12/0.11	16/13	2550/2900	89/115	0.30/0.35	45/51	520